

JINP40
Precision Industry Co., Ltd.

經寶精密
泰國精密金屬機構件製造商

TWSE:5284 jpp-KY

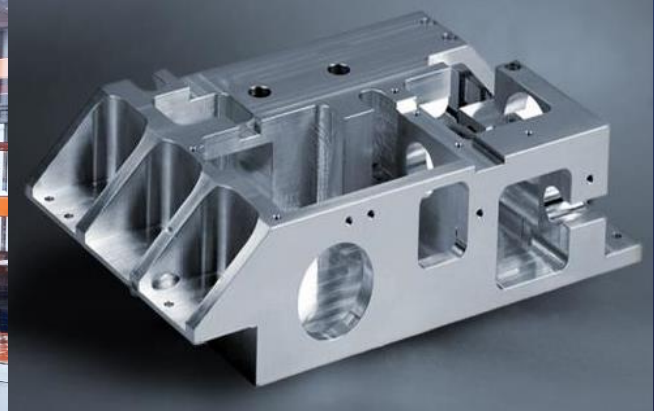

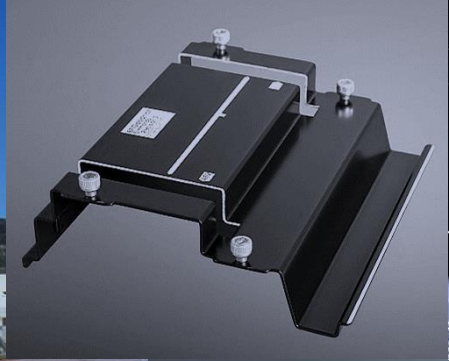
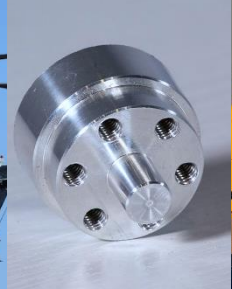

YOUR global partner

利基型產品
少量客製化
兼具大量生產

基本資料



經營績效



產品介紹



電動機車



航太製造



全球布局

歐洲泰國兩大據點

Year : 2022

	ASIA	EUROPE
	45M	9M
	1100	90
	1	3

EUROPE

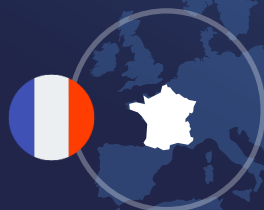

AGILITEAM
BY JINPAO

JINPAO



BANGKOK



基本資料

公司歷程



工業設計

多語系專業團隊

設計、原型製作、測試

一站式解決方案
(included testing after integration)

- DFM Service
- Co-design
- CAD Systems
(Autocad, CATIA, SolidWorks)
- Cyber Physical Simulations
(PAM-Stamp)
- Paperless Hyper Document – PHD
- Project Management
with FMEA risk analysis

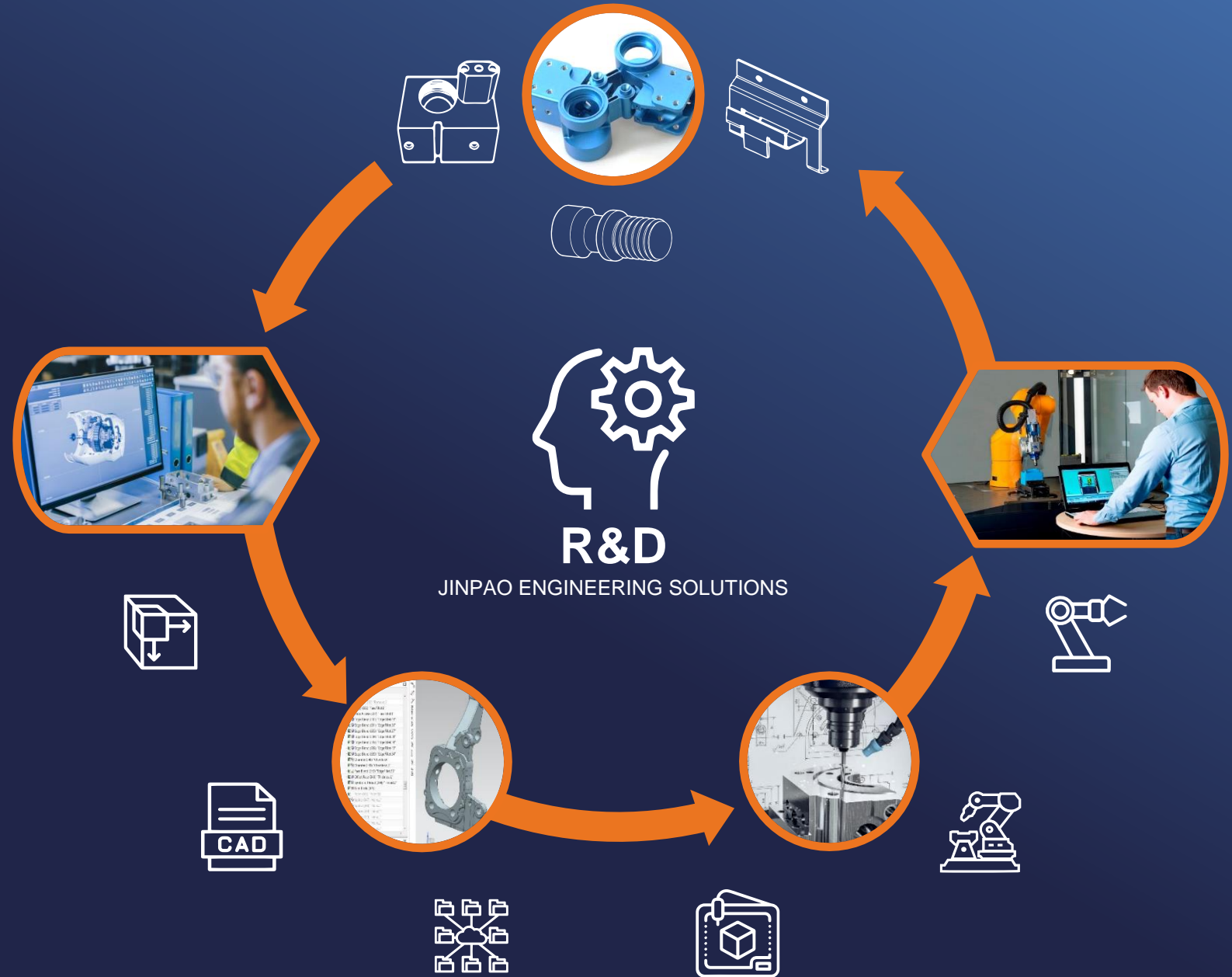

價值提升 一站式整合服務

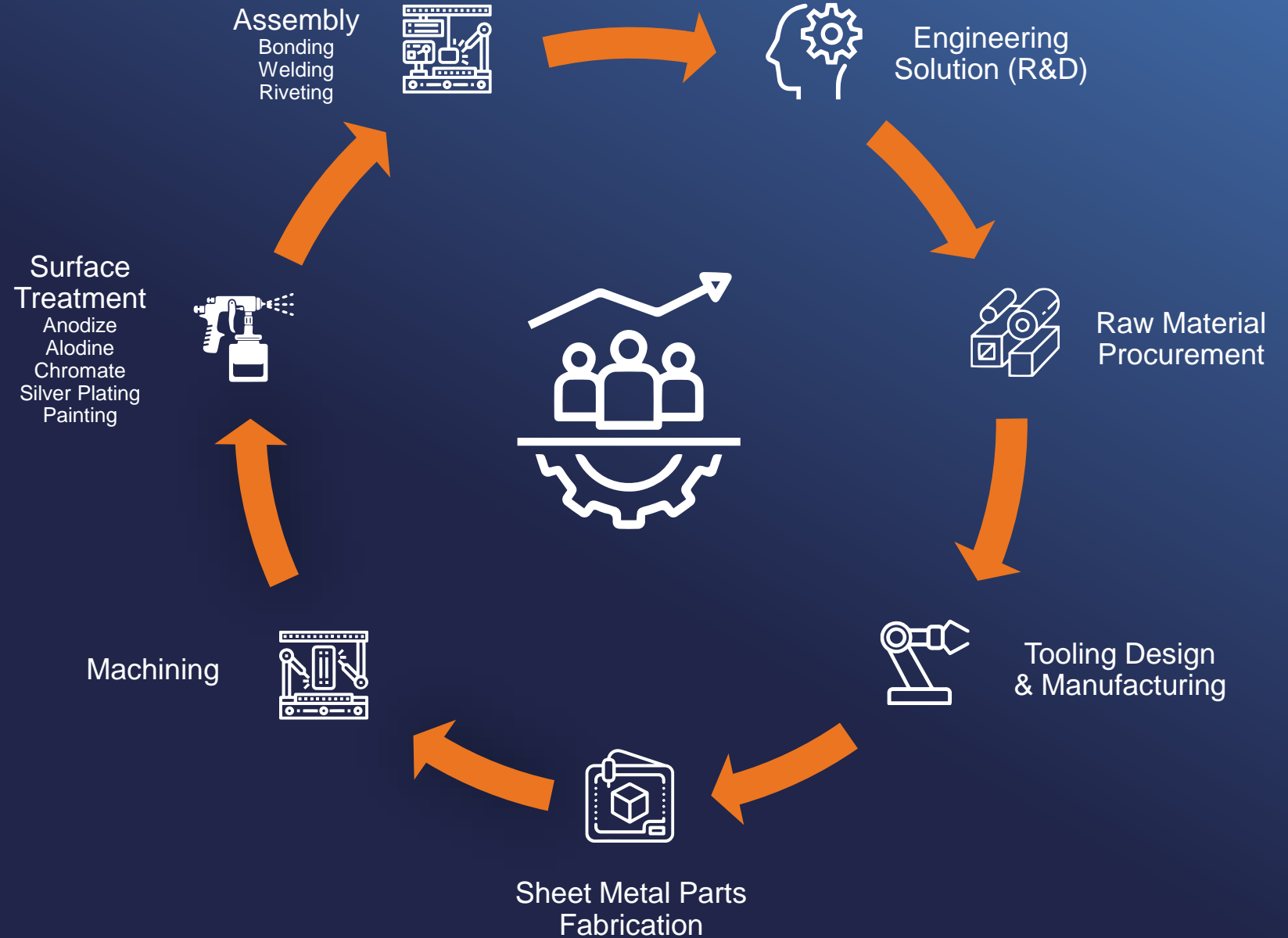

MATERIAL TYPE

Aluminum, Stainless Steel,
Inconel, Copper Alloys,
Nickel Alloy, Titanium

Plate, Sheet, Bars, Extrusion, Die
Casting

經寶工業 4.0 Framework

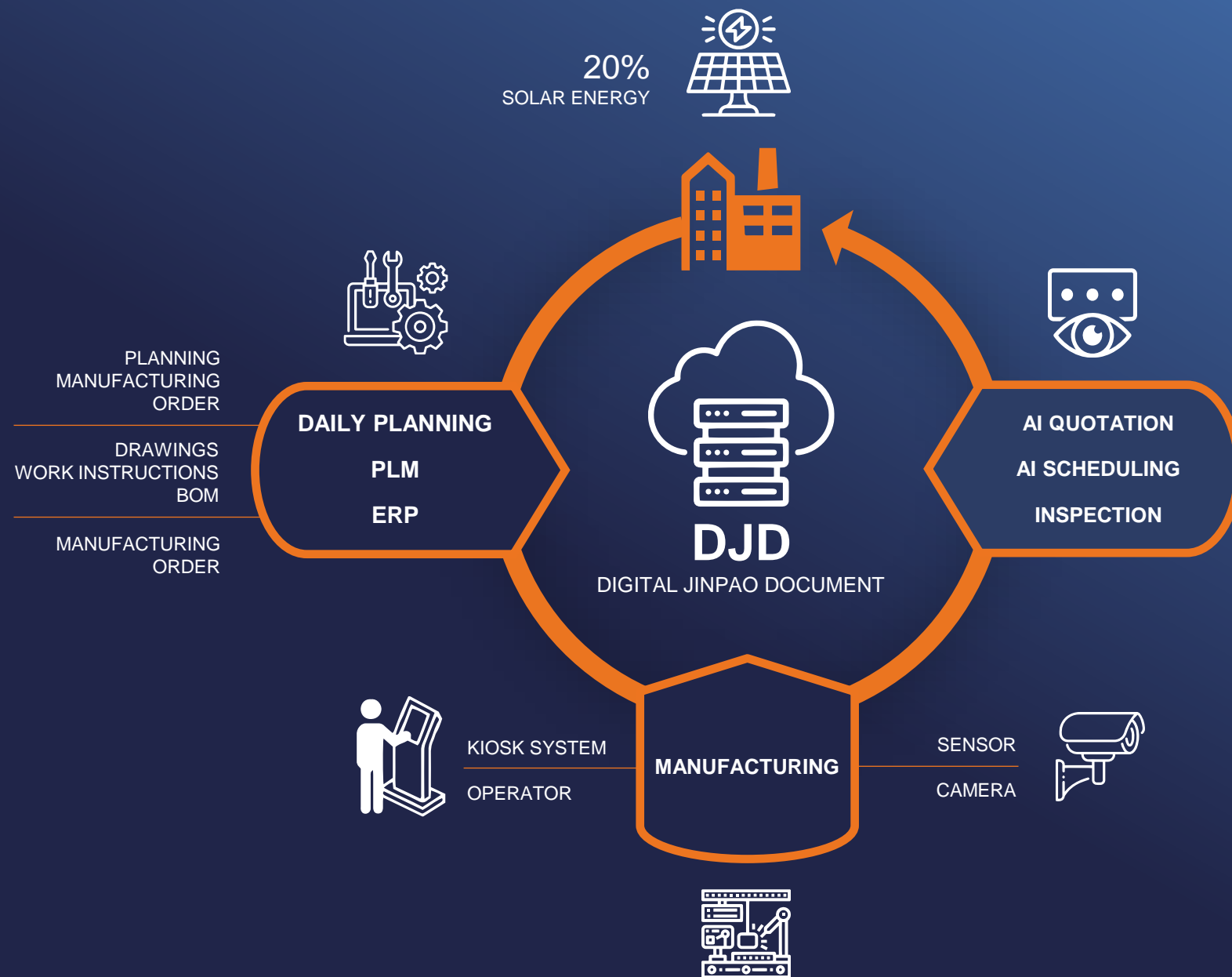

FACTORY 4D TOUR



工藝技術

ISO、Nadcap 認證

OUR CERTIFICATIONS



afaq
EN/AS/JISQ 9100
Aéronautique
AFNOR CERTIFICATION



afaq
ISO 9001
Qualité
AFNOR CERTIFICATION



afaq
ISO 13485
Santé Médical
AFNOR CERTIFICATION



TUV NORD

ISO 14001
ISO /IATF 16949



Accredited
NadcapTM

Welding
Chemical Processing
Non-Destructive Testing
Heat Treating

New



REACH
COMPLIANT



RoHS
COMPLIANT

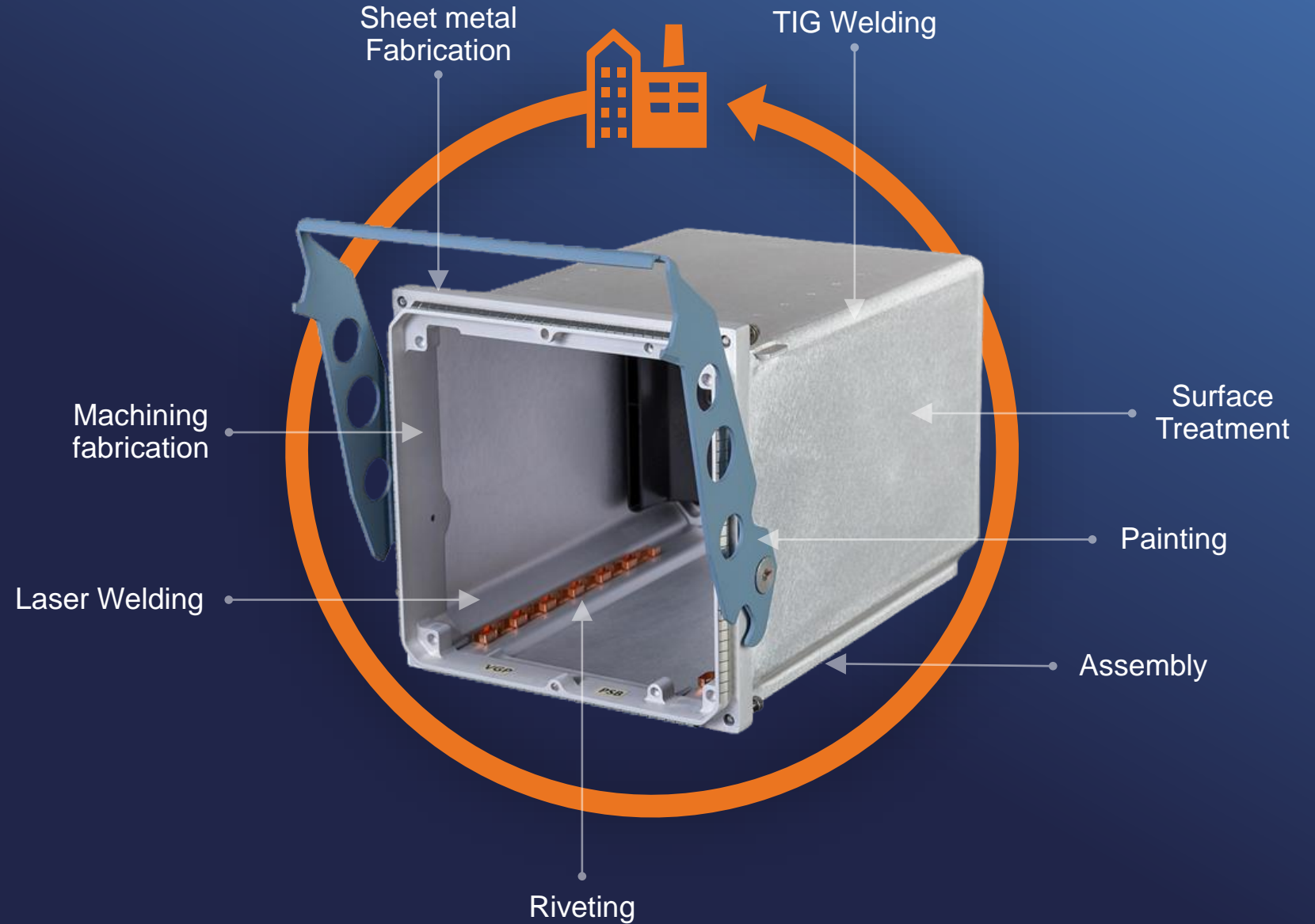



YOUR global partner

Custom Mechanics
High-Mix
Low-Volume

經營績效



2019 – 2022 營收趨勢

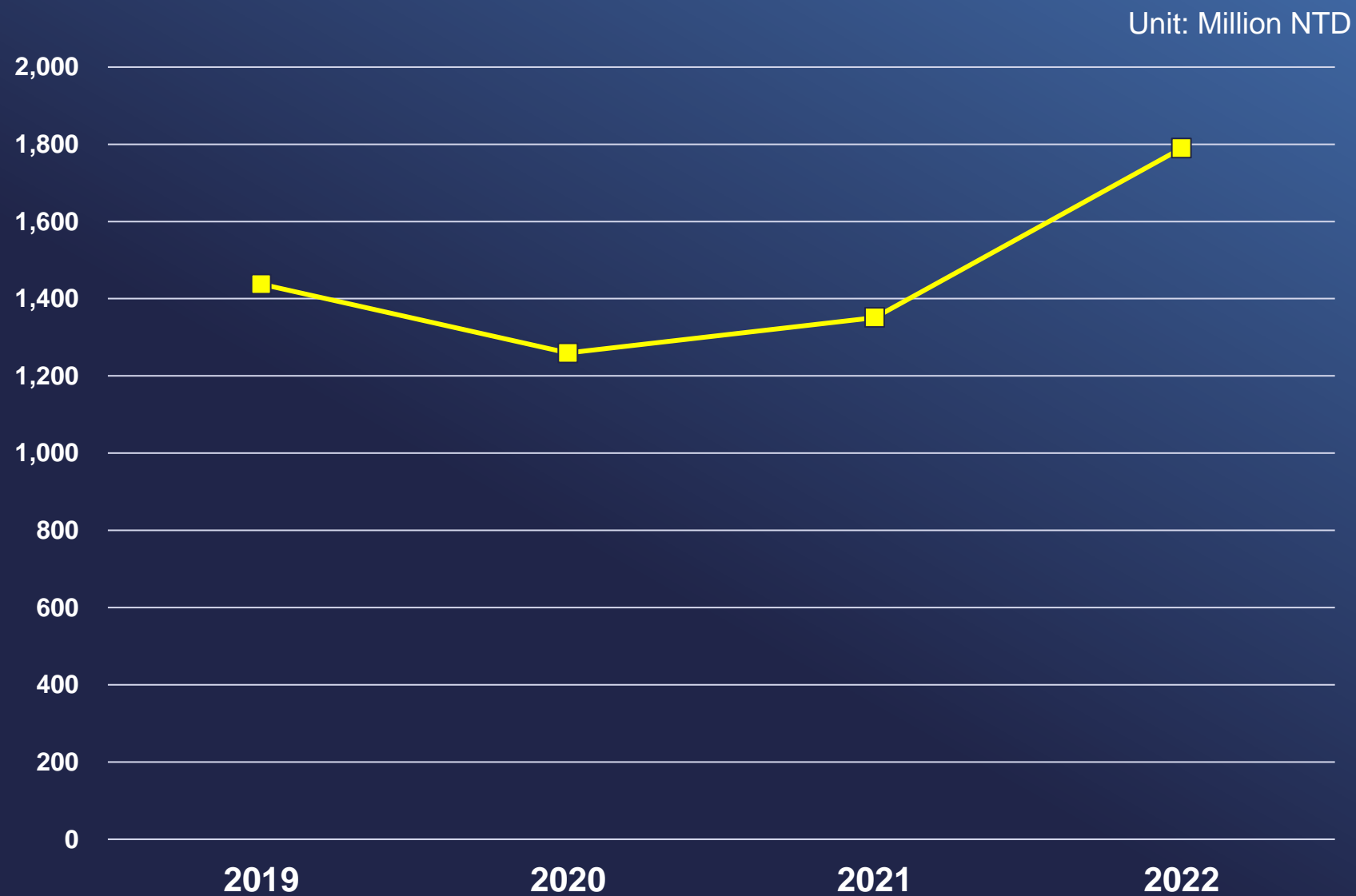

產品分布圖

- Electronic 電子
- Aerospace 航太
- Telecommunication 通訊
- Others 其他

2021

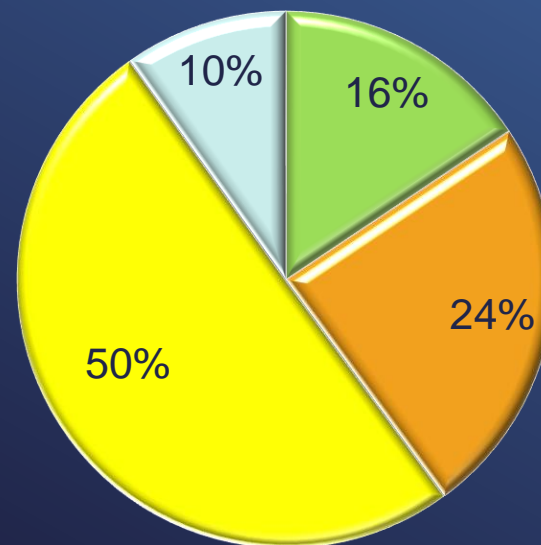

- Electronic
- Aerospace
- Telecom
- Other

2022

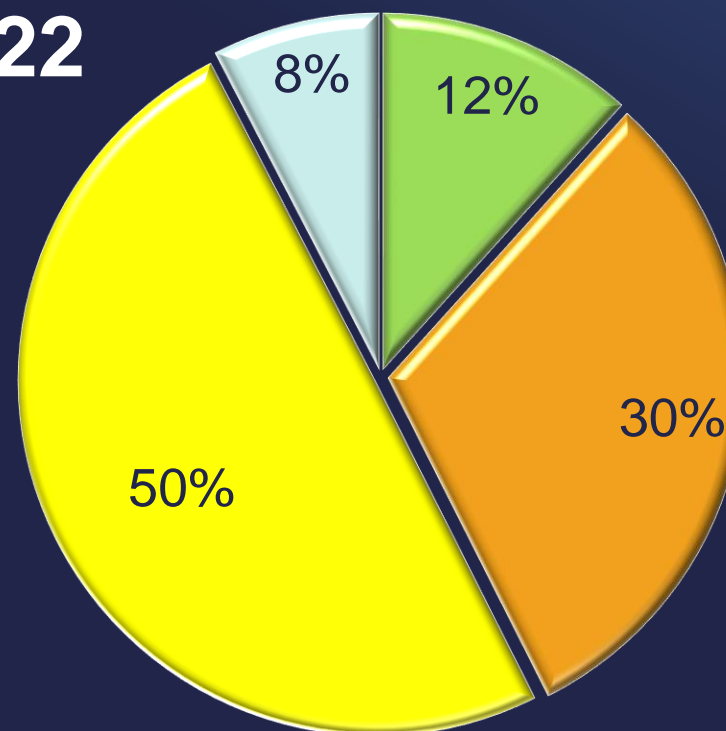

- Electronic
- Aerospace
- Telecommunication
- Other

營收分布 歷年長條圖

- Electronic 電子
- Aerospace 航太
- Telecommunication 通訊
- Others 其他

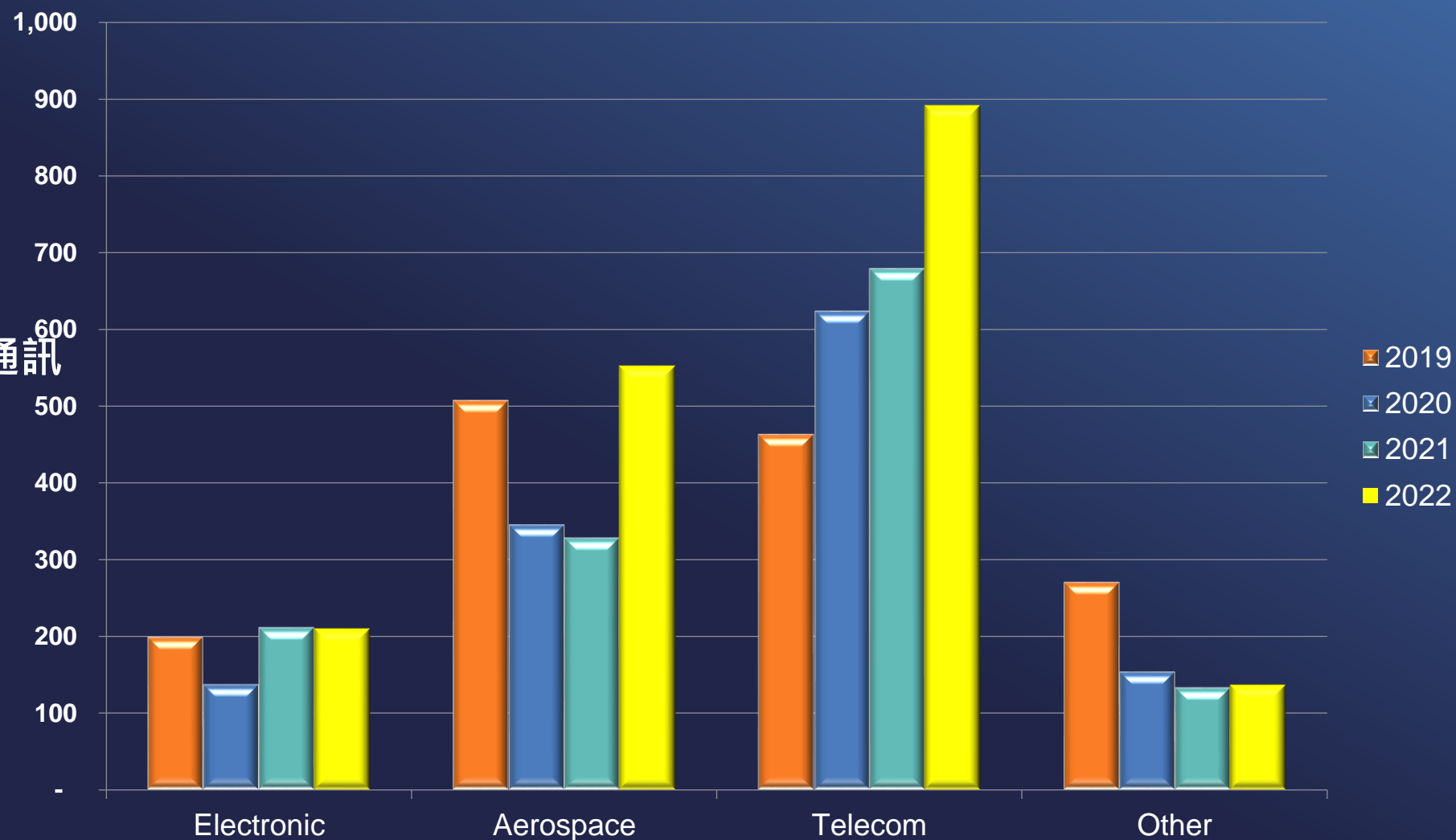

GM % and EPS

— GM % — EPS

毛利 & EPS

- 2019
- 2020
- 2021
- 2022





YOUR global partner

Custom Mechanics
High-Mix
Low-Volume

產品介紹



雲端中心
伺服器機櫃

42U
48U
48U Open Rack

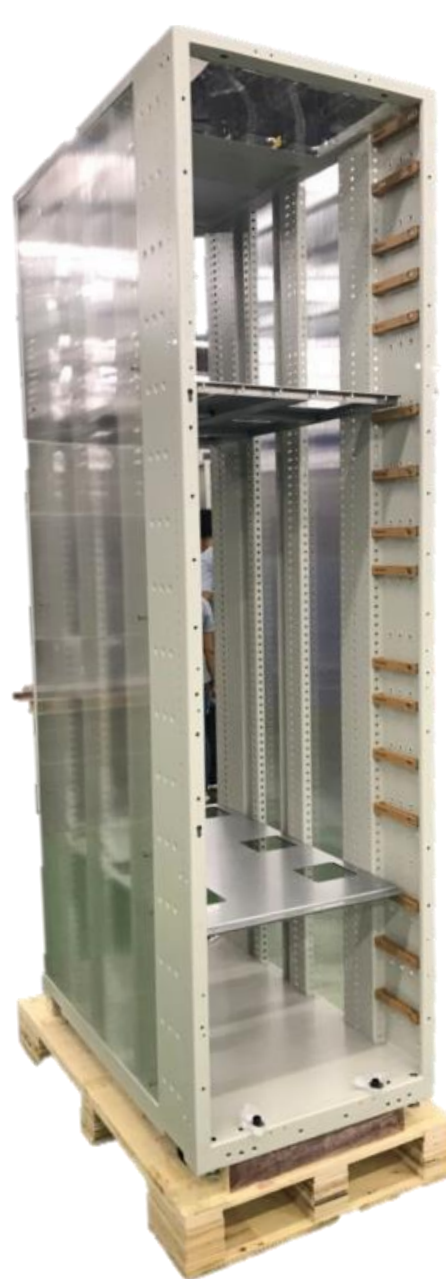

雲端中心

- 伺服器機殼

1U

2U

3U

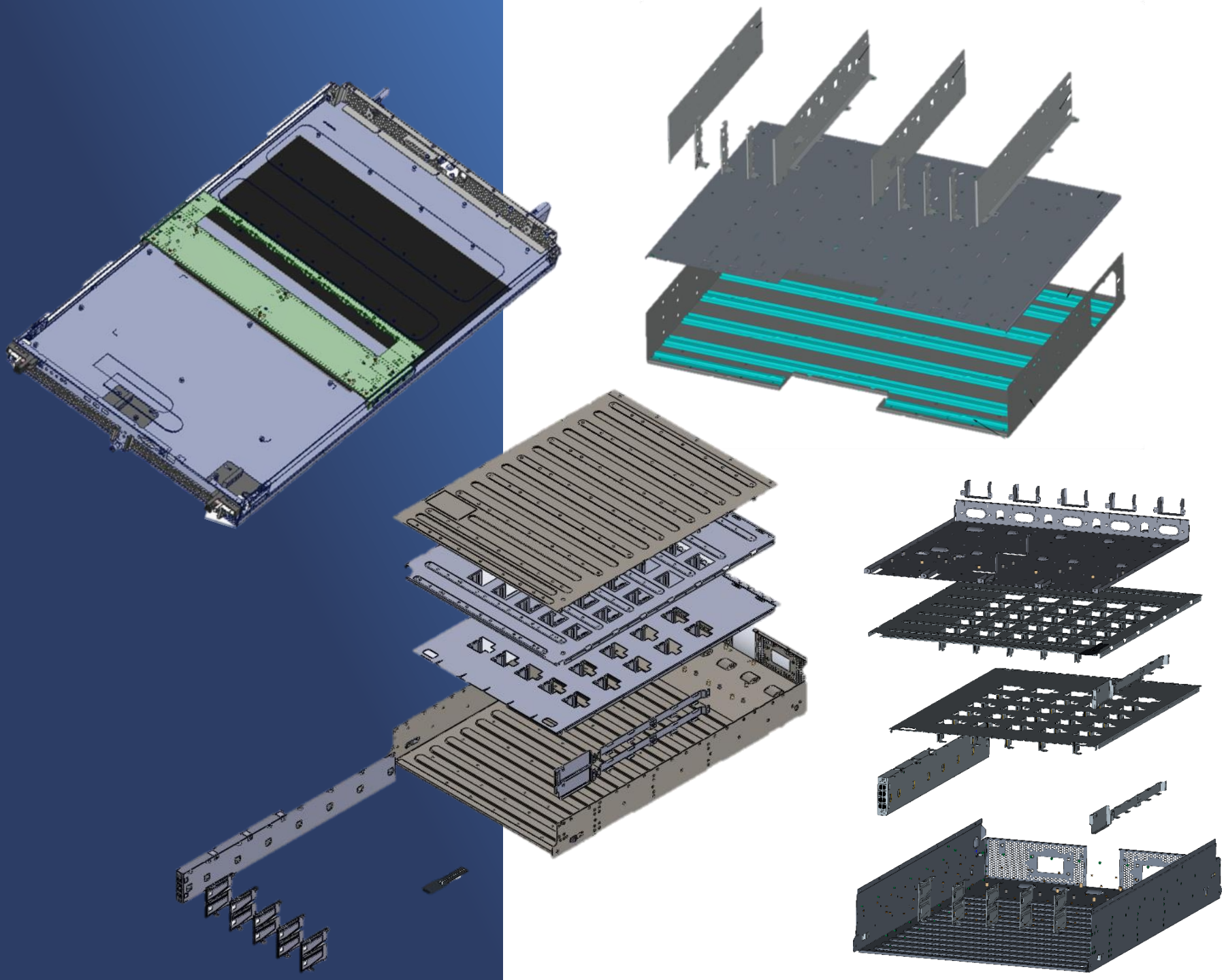

PCB組裝

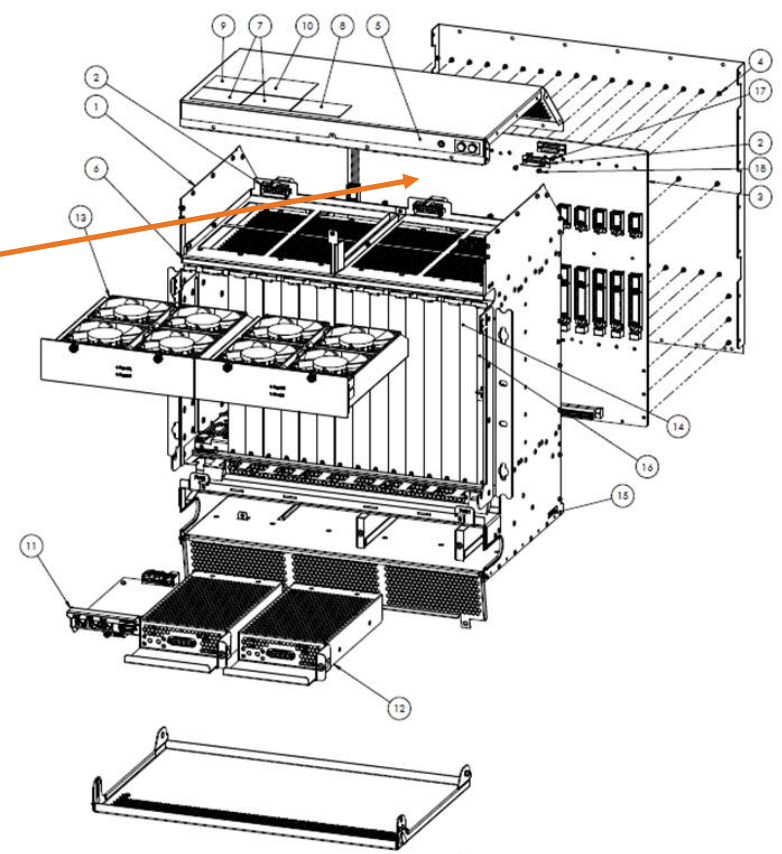
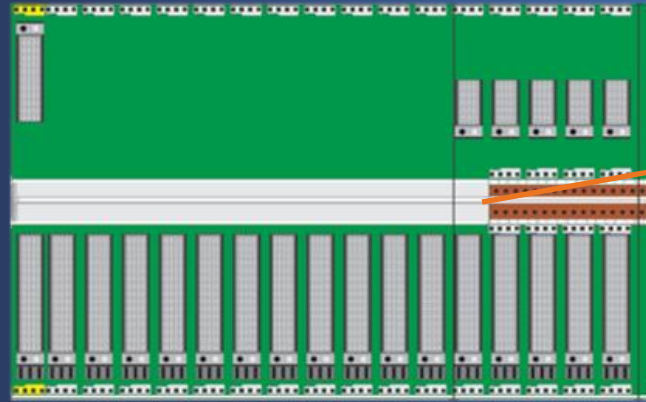

食品類機構件 數位飲料機



TECHNOLOGY AND FOOD SAFETY

JINPAO provide manufacturing of equipment for Automotive industry, included:

- food scanners
- vending machines
- X-Ray Metal Checker
- Automatic Combination Weightier
- Milk Analyzer



All Product Application



智慧醫療站

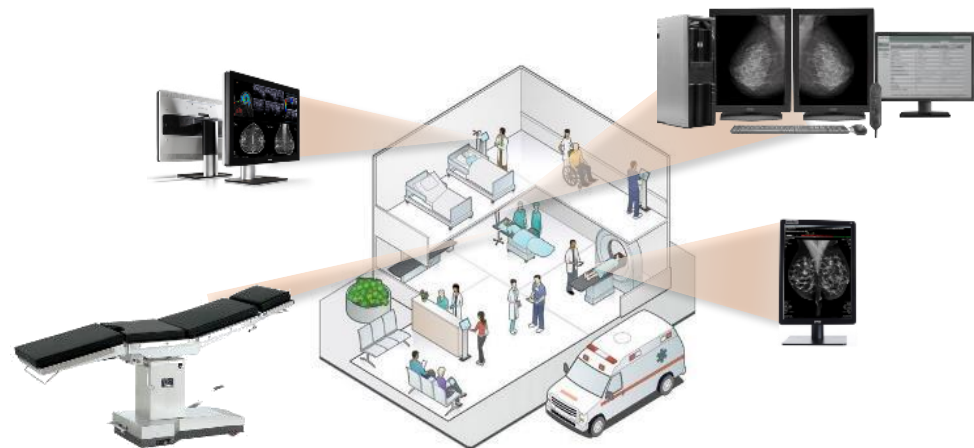



YOUR global partner

Custom Mechanics
High-Mix
Low-Volume

電動機車

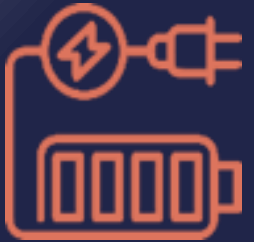

電動機車 發展進程

JINPAO

- Concept
- Original Design Manufacturer

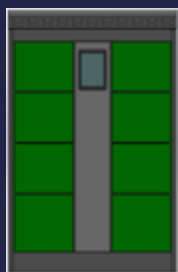

2021
Feb

JINPAO & Outsource

- R&D on battery related topics
- Design of electronic part
- Develop Application & Control



2021
Mar

JINPAO

- Assembly & Install to Cabinet.
- Cabinet.
- Wiring diagram.
- Built in program.



2021
Apr

JINPAO

- Test for the efficiency of charging the battery.
- Temperature.
- Cost of charge.



2021
May

JINPAO

- API for creating platform.
- Payment.
- Parameter of Battery.



2021
Jun

JINPAO

- Battery charger development
- Low cost.
- Open parameter.
- Communicate in RS232 format.

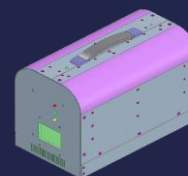

2021
Dec

JINPAO & Outsource

- R&D on multi-voltage charge topics
- Design of electronic part
- Optimized by experts
- Design of electronic part
- Develop Application & Control



2022
Feb Mar

JINPAO

- API for creating platform.
- Payment.
- Parameter of Battery.
- Update display to show battery charging parameters
- Trial Run.



2022
Jun

JINPAO for NSTDA

- Concept
- Original Design Manufacturer
- Developed a multi-voltage battery charging system.

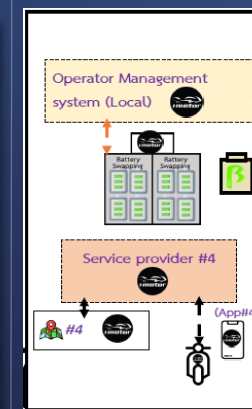

2022
Jul Aug

2023

泰國第一台
國產電動機車



Vapor

- Design in Thailand
- Made in Thailand

Vapor

COLOR OPTIONS



泰國第一台 國產電動機車



電動機車



● BIKE SPECIFICATION ●



Vapor

Electric Motor Power
3,000 W.

Max Speed
100 km/h.

Avg Speed
75 km/h.

Net Weight
96 kg.

Front Tire Size
100 / 90 - 12

Vehicle Size

(W)760 x (L)1,895 x (H)1,220 mm.



Battery Type
Lithium - ion (NMC)

Battery Specification
Non Swapable 72V 40 Ah.
Swapable 72V 25Ah x2

Charging Distance
120 km. / 1 Charged

Brakeing System
Disc Brake FR&RR

Rear Tire Size
130 / 70 - 12

Gear Reverse
Yes



Battery Capacity



ELECTRIC POWER



EV

換電站 充電樁 Energy



FEATURE AND SPECIFICATION

RFID / Scan payment
Full charging time : 1~5 hours
(depend on type of battery)
Charging power :
72V 40A max 2880W
Charge 2 battery / station
Charge status indicator and alert
sound.

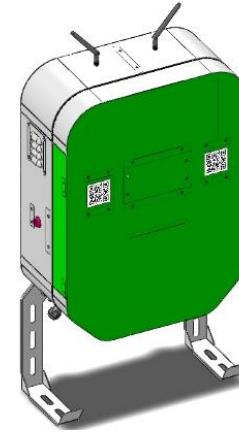

換電站 (NSTDA)

National
Science and
Technology
Development
Agency

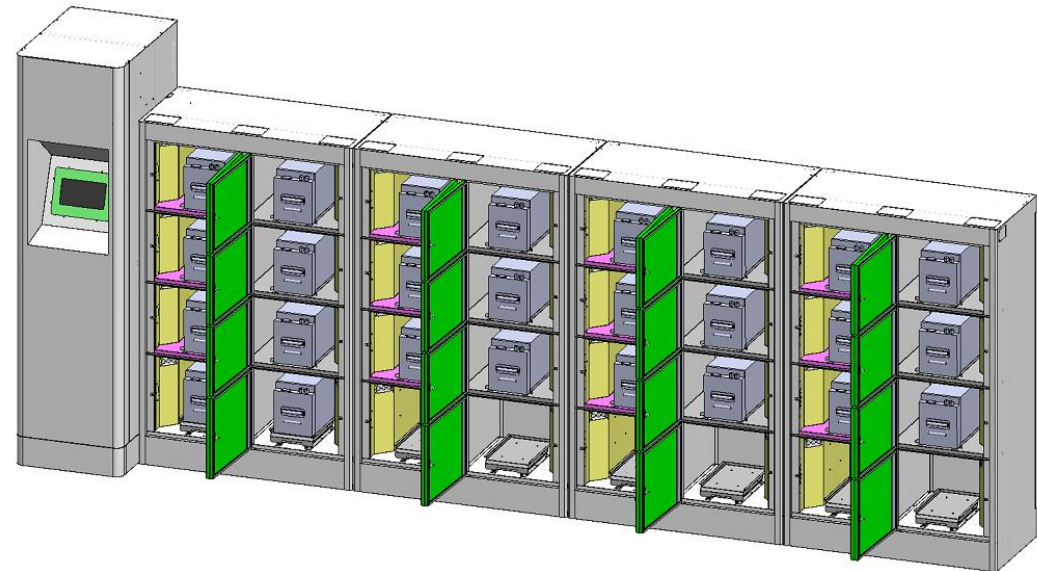
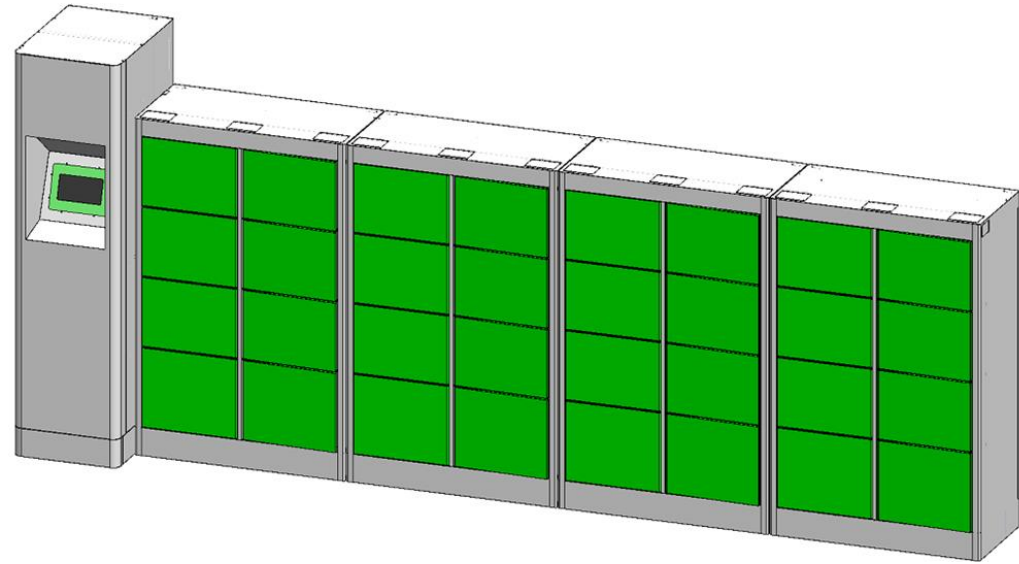
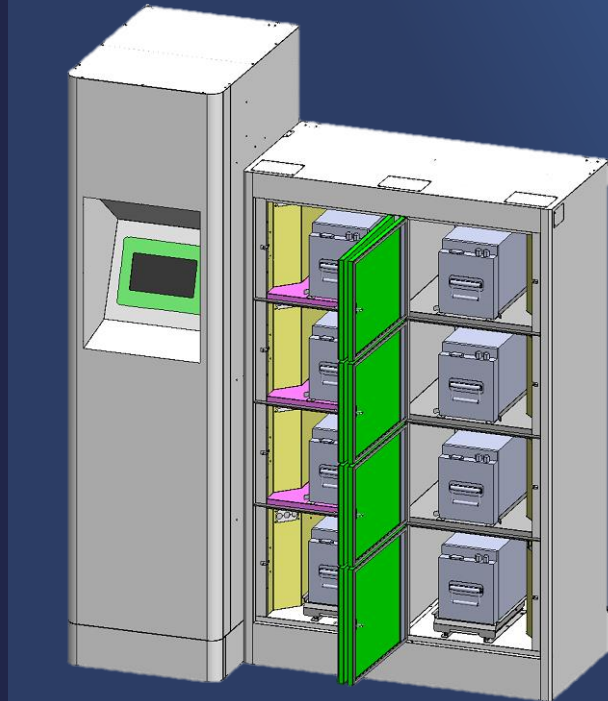
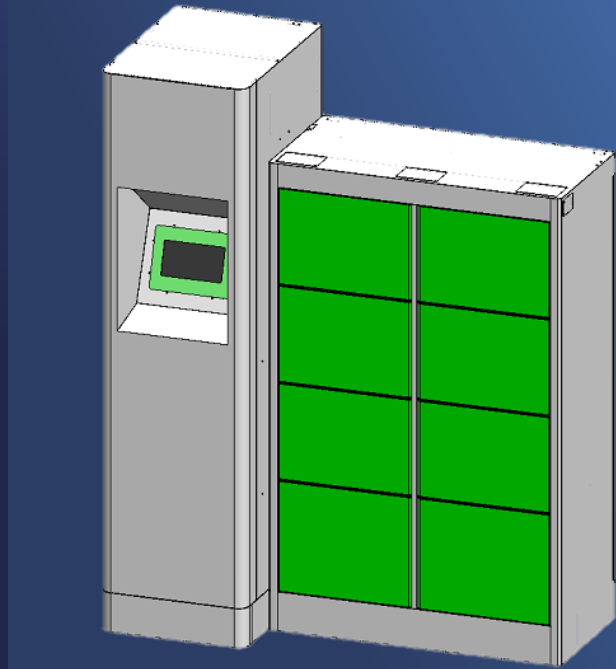

換電站 (NSTDA)

National
Science and
Technology
Development
Agency

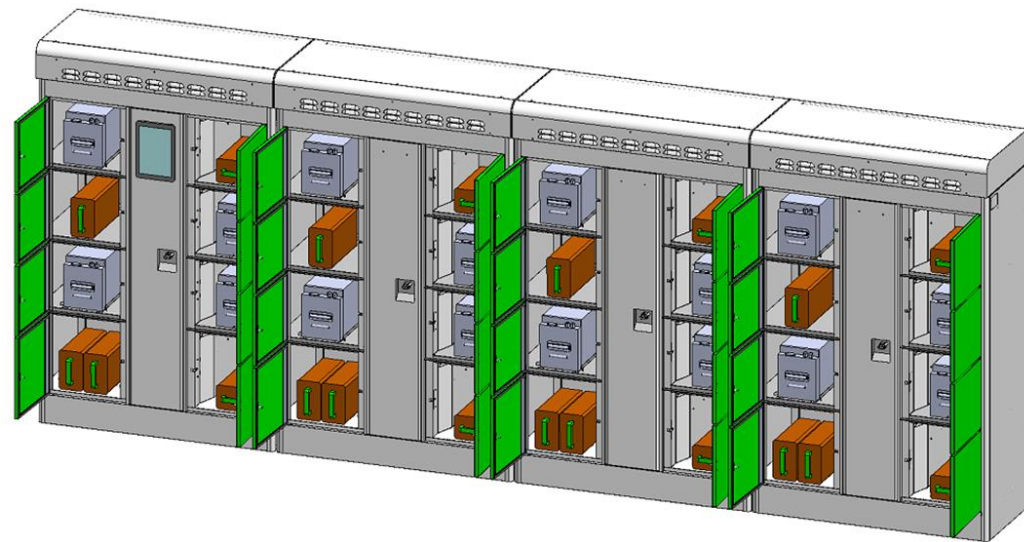
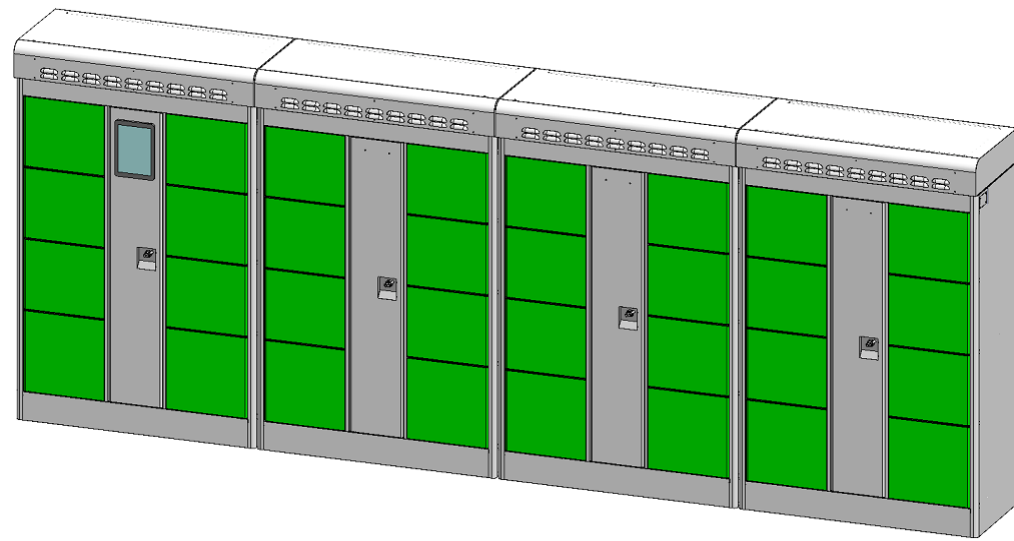
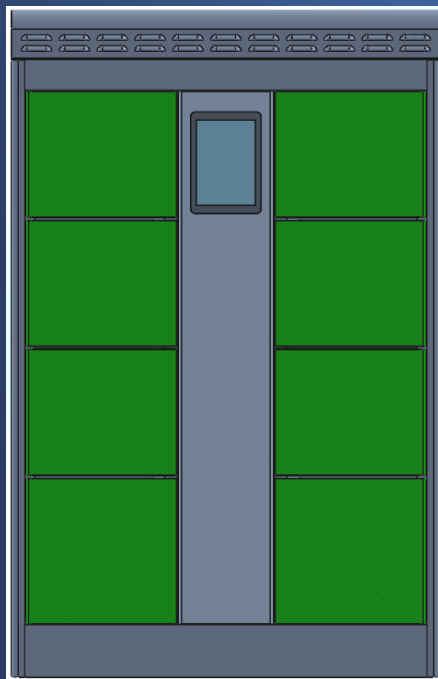

換電站 (NSTDA)

National
Science and
Technology
Development
Agency



換電站 (HONDA)

Global SPEC



充電樁 Energy



FEATURE AND SPECIFICATION

RFID / Scan payment
Full charging time : 1~5 hours
(depend on type of battery)
Charging power :
72V 40A max 2880W
Charge 2 battery / station
Charge status indicator and alert
sound.

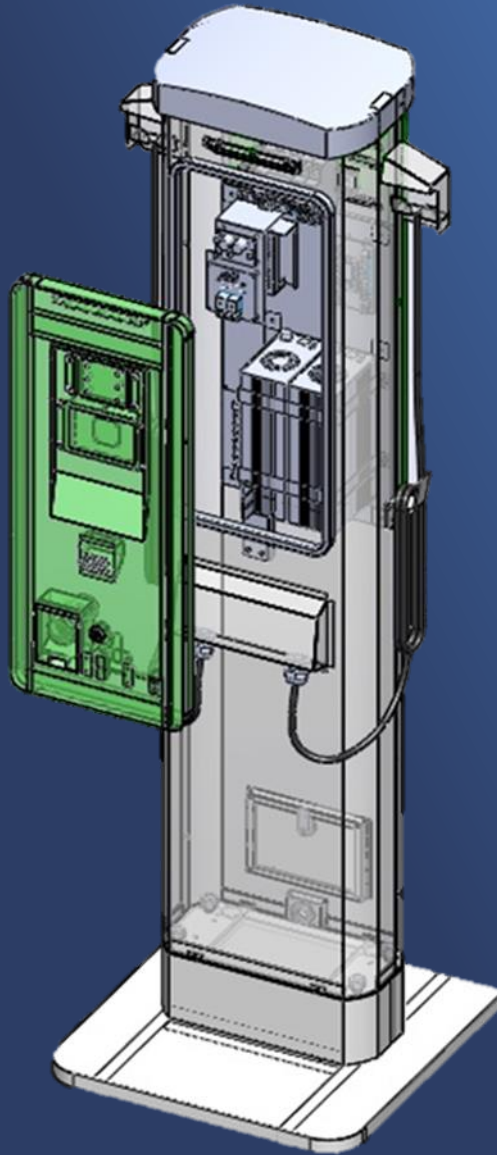

電池交換系統 應用程式

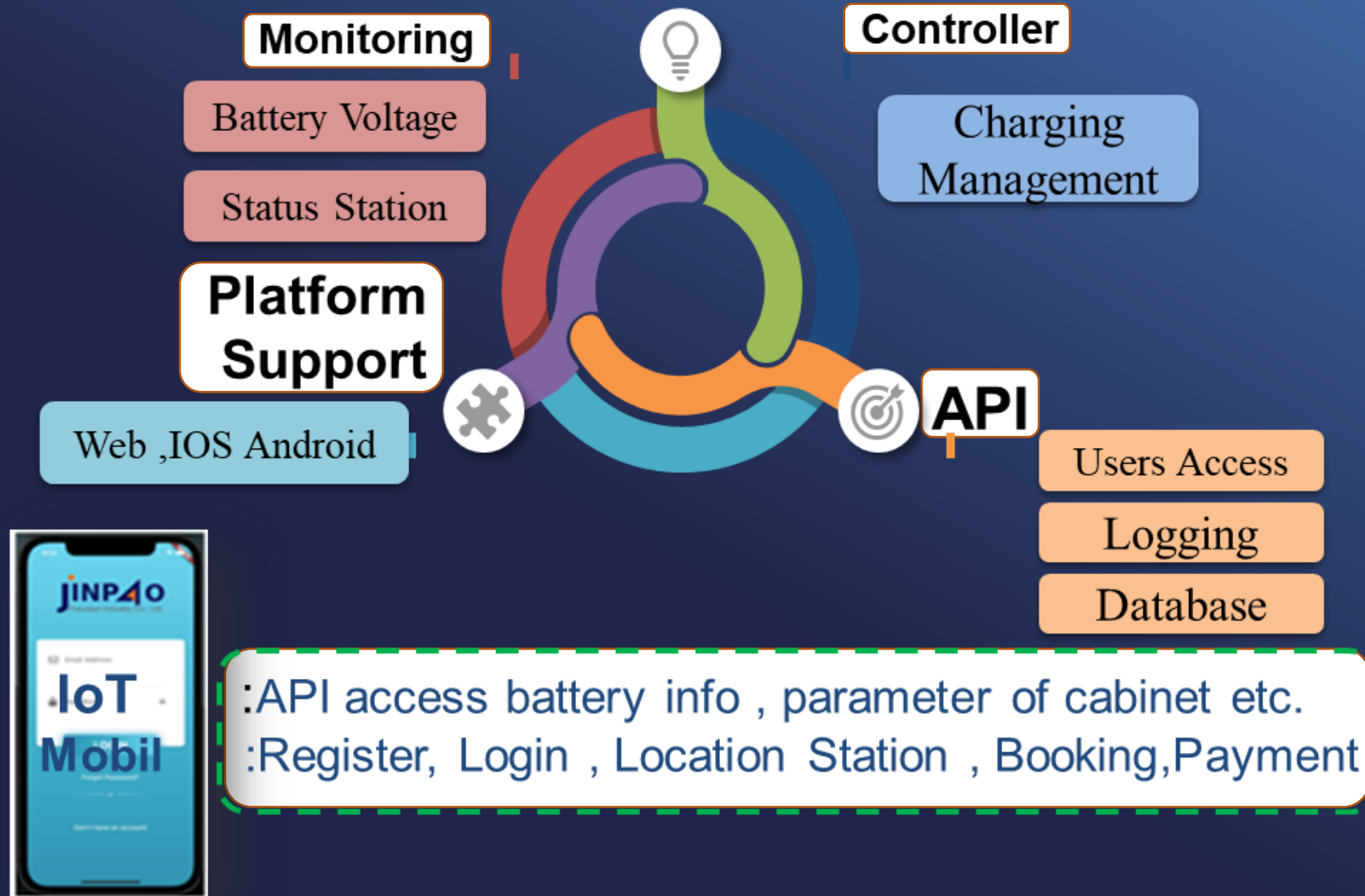

JINPAO APP

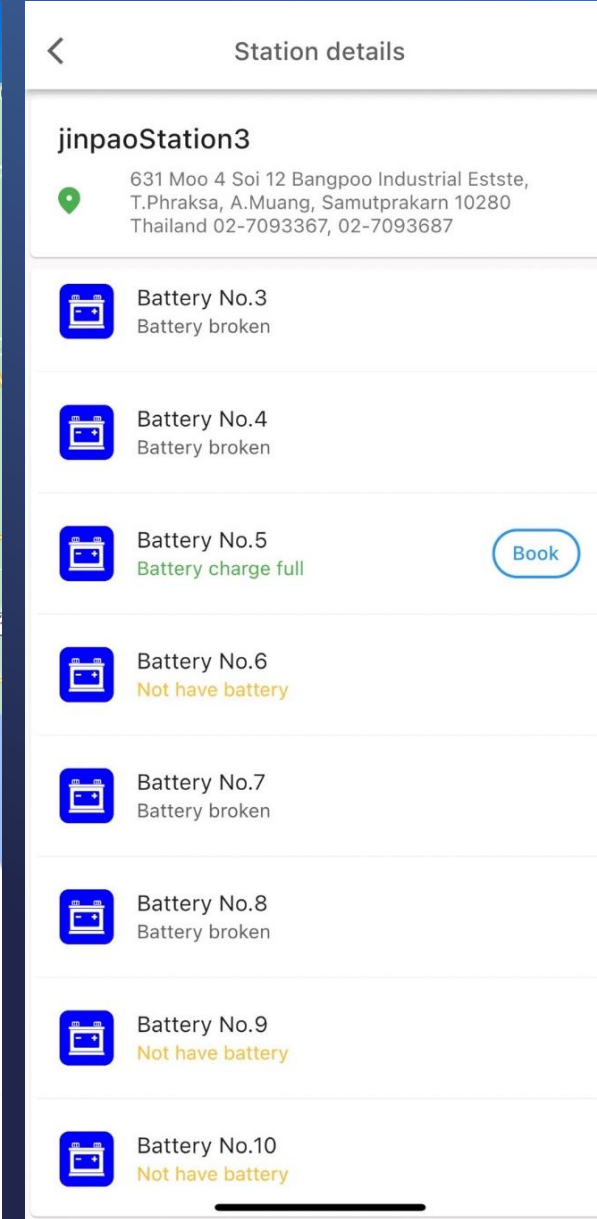
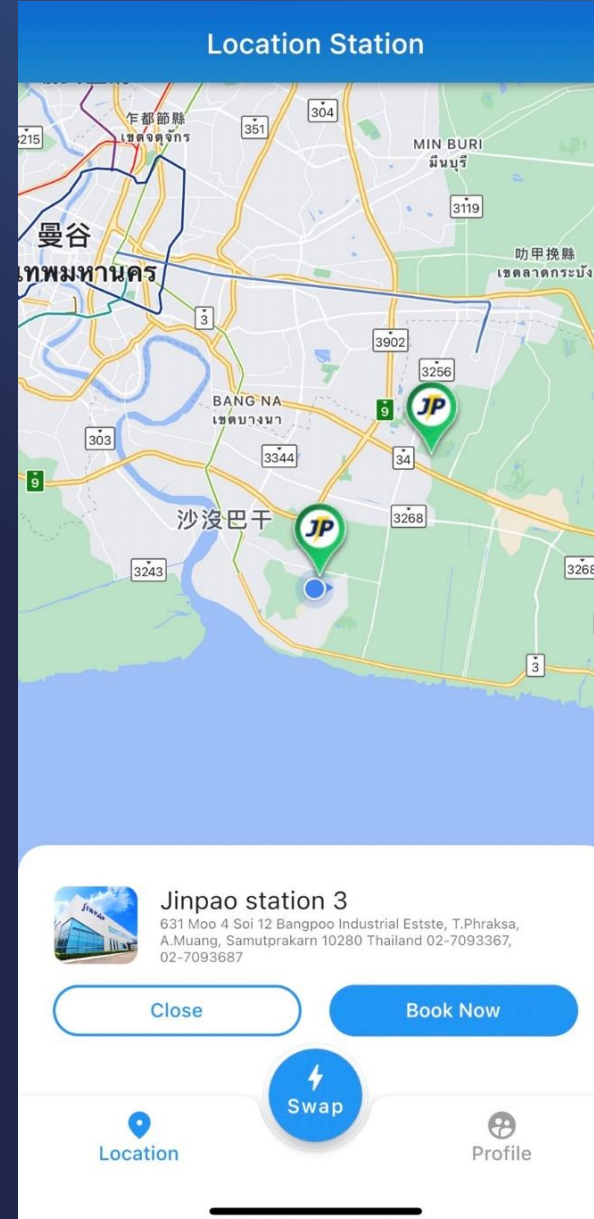
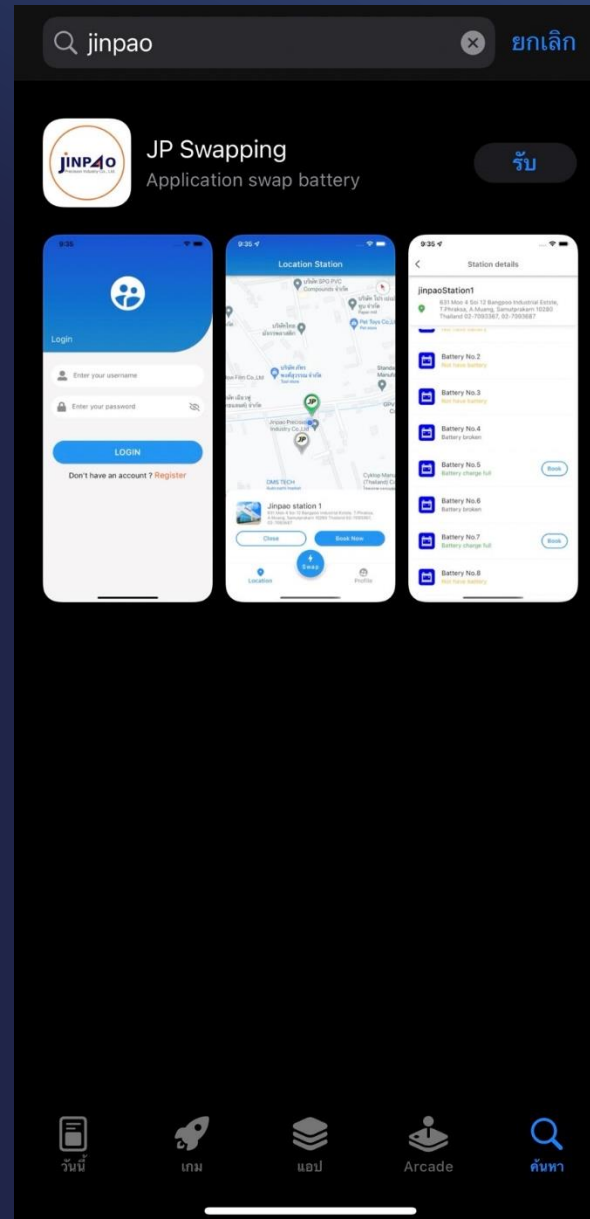

JINPAO APP

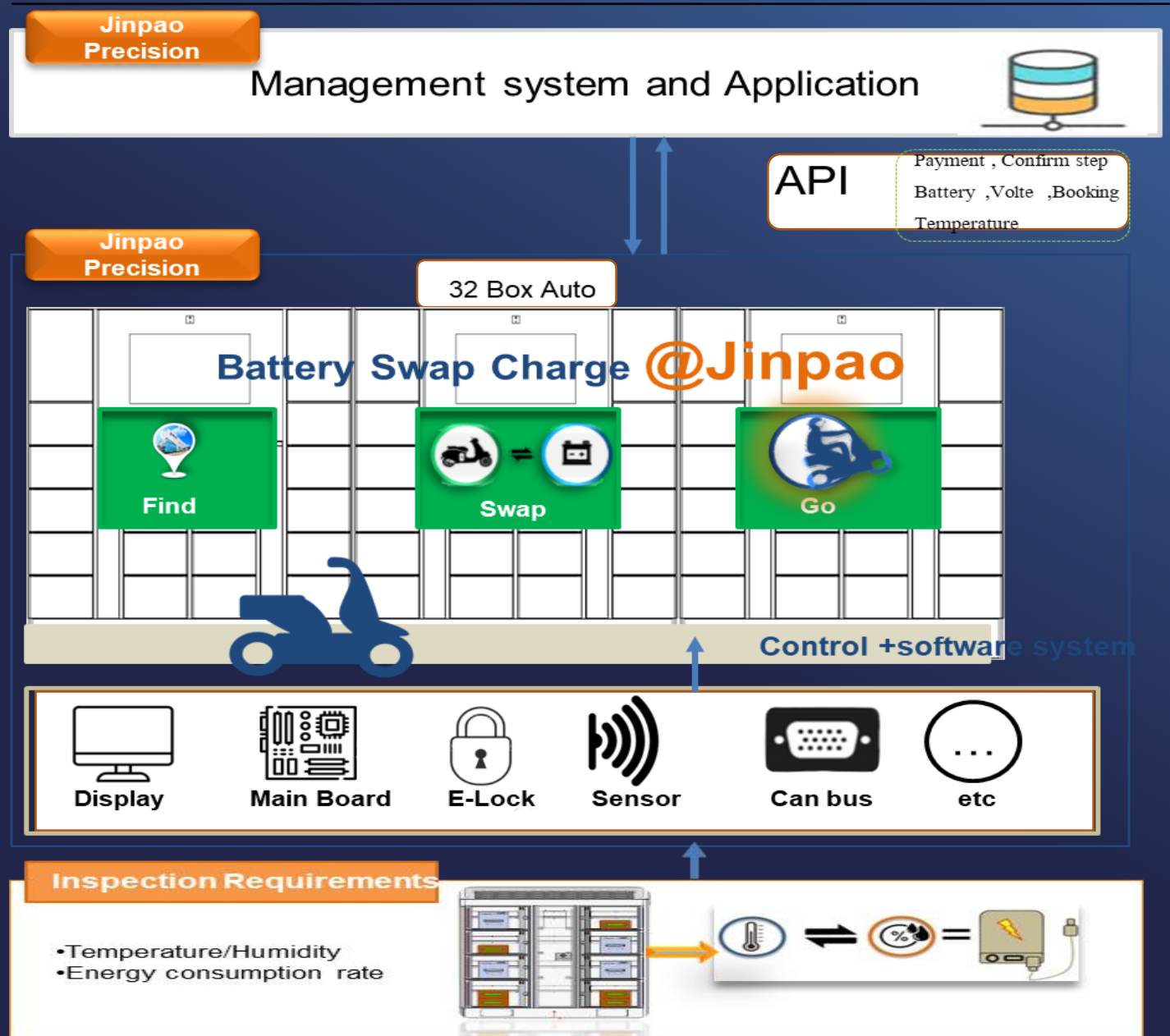

JINPAO APP

Smart Charger Support

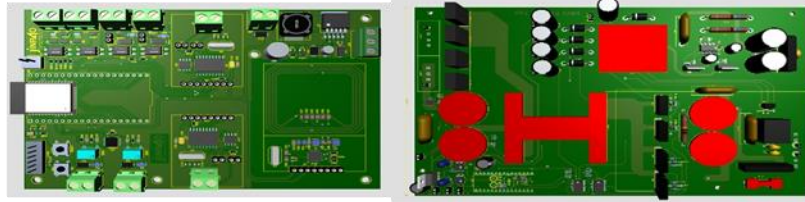

- Internal :CAN BUS PROTOCOL
- External :RS232
- Wireless :2.4 GHz(Optional)

CAN BUS PROTOCOL @Jinpao



JINPAO CAN-BUS

Serial Port: COM17
Baud Rate: 115200
Disconnect

Battery Code Error : 0

Serial Number: JP20210924-0001
Power Battery: 0 W
Temperature: 22 °C
Max Voltage : 3.29 V (Cell No. : 18)
Min Voltage : 3.25 V (Cell No. : 17)
Residual capacity: 5.5 Amp

Voltage Cells Total : 24

Cell No1 : 3.29 V Cell No2 : 3.29 V Cell No3 : 3.28 V Cell No4 : 3.29 V Cell No5 : 3.29 V Cell No6 : 3.29 V Cell No7 : 3.29 V Cell No8 : 3.29 V
Cell No9 : 3.29 V Cell No10 : 3.29 V Cell No11 : 3.29 V Cell No12 : 3.29 V Cell No13 : 3.29 V Cell No14 : 3.28 V Cell No15 : 3.29 V Cell No16 : 3.27 V
Cell No17 : 3.25 V Cell No18 : 3.29 V Cell No19 : 3.29 V Cell No20 : 3.29 V Cell No21 : 3.29 V Cell No22 : 3.29 V Cell No23 : 3.29 V Cell No24 : 3.29 V

SOC: 100%
Voltage: 78.8 V
Current: 0 A

Clear

Example_Data: [{"Battery_Serial_No": "JP20210924-0001", "SOC_of_battery": 100.00, "Battery_Voltage": 78.80, "Battery_Current": 0.00, "Maximum_voltage": 3.29, "Minimum_voltage": 3.25, "cell_Max": 18, "cell_Min": 17, "Residual_capa": 5.5}

Power Charger Board

經寶智慧充電系統



Smart charge

72V/20Ah

48 V

60 V

72 V

48,64,72V/20 Ah
Multi Voltage Charger



YOUR global partner

Custom Mechanics
High-Mix
Low-Volume

航太



航太發展進程(Portfolio)

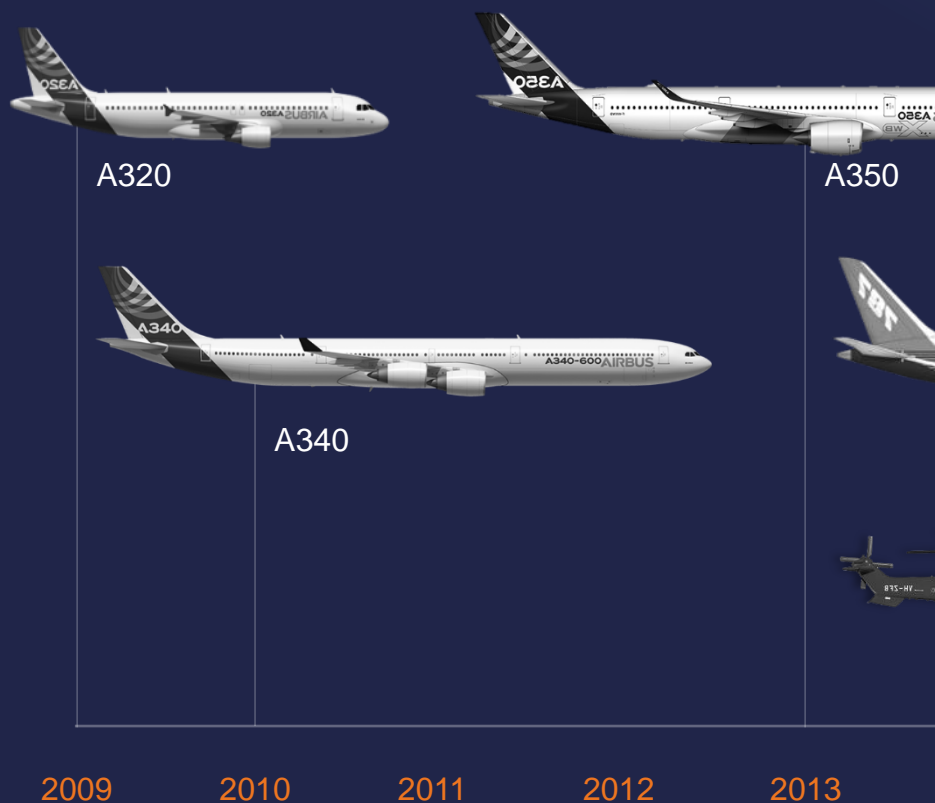



Geo-Informatics and Space Technology
Development Agency (Public Organization)



SATELLITE TECHNOLOGY LTD

Certificate

This is to certify that

Jinpao Precision Industry Co., Ltd.

has passed the SSTL supplier onboarding process
for satellite manufacturing and have delivered
finished goods in support of the THEOS-2 project



(Pakorn Apaphant, Ph.D.)
Executive Director
Geo-Informatics and Space Technology
Development Agency
Signed: 10th March 2023



(Kuo Wong)
Head of Subcontracts
Surrey Satellite Technology Limited
Signed: 8th March 2023



THEOS-2

DOING SPACE DIFFERENTLY.



THEOS-2



Pilatus



2020

2021

單走道客機 生產計劃



AIRBUS 生產計劃



	Current Program	Current Rate per month	Planned Min/Max Rate per month	A/C st40* 2021	A/C st40* 2022	A/C st40* 2023	A/C st40* 2024
A320	DN	45	66 (Oct-2023)	488	596	731	Under investigation
A330	CP	2.2	2.8	22	25	31	30
A350XWB (St50)	V	5	6 (Jan-2023)	50	22	66	66

航電機構件
航電結構件
Mechanical Parts



航太 目標產品

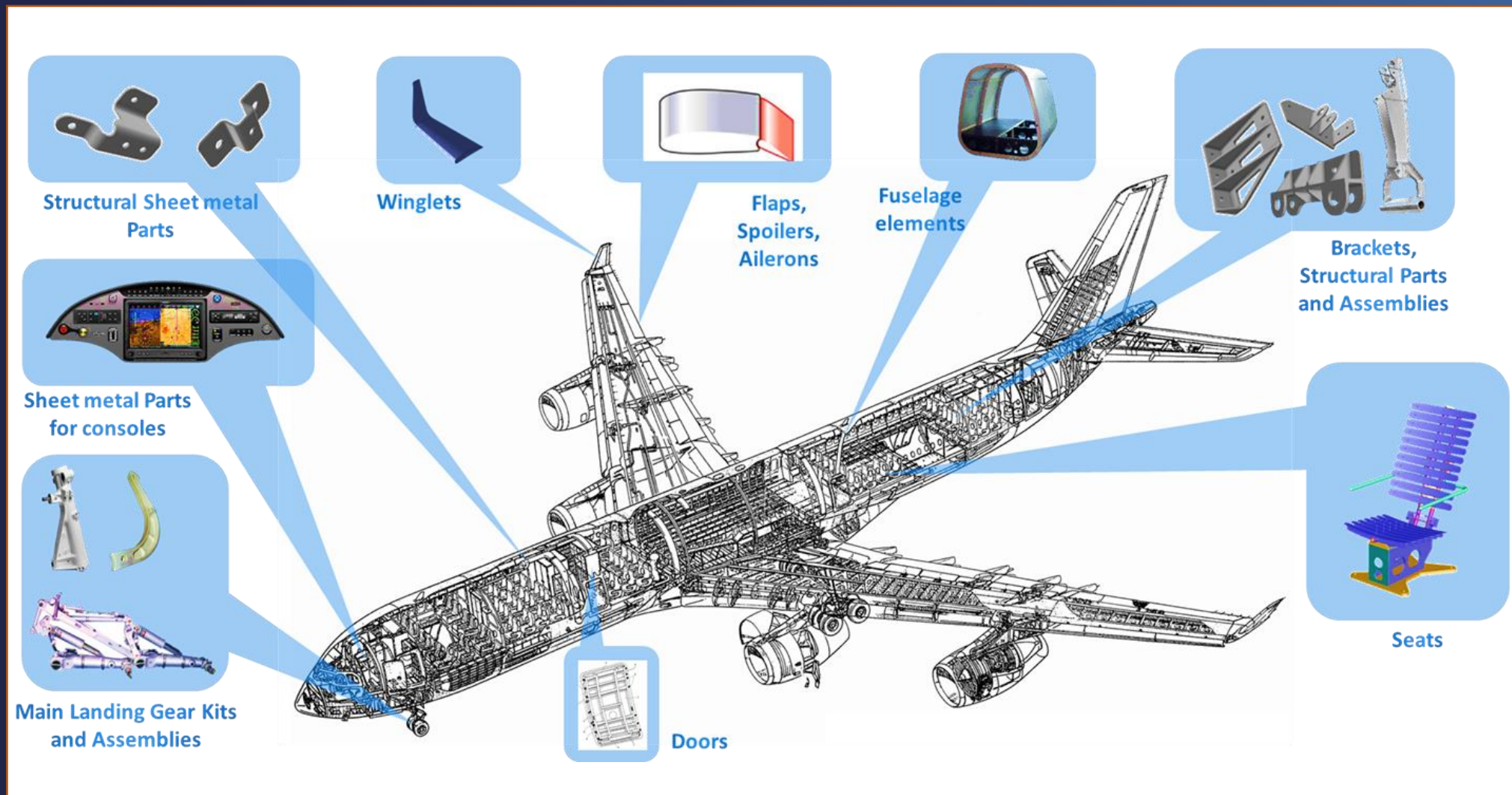

A320 and A330 客機改貨機 (P2F) Conversion



3,000+ Parts
Y2022: FA
Y2023: MP



THANK YOU