

**JINP40**  
Precision Industry Co., Ltd.

**Integrated**  
Engineering &  
Manufacturing

**jpp-KY**  
TWSE:5284

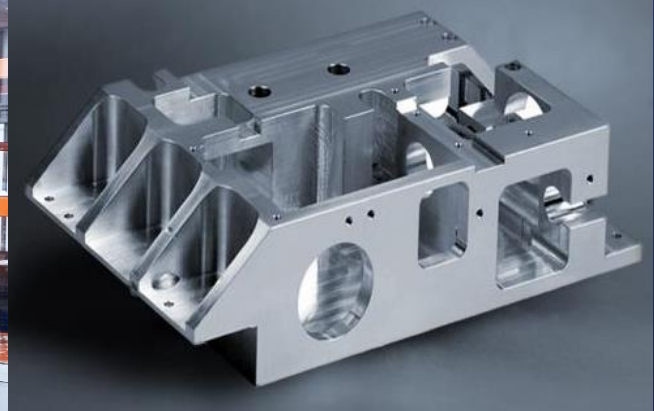
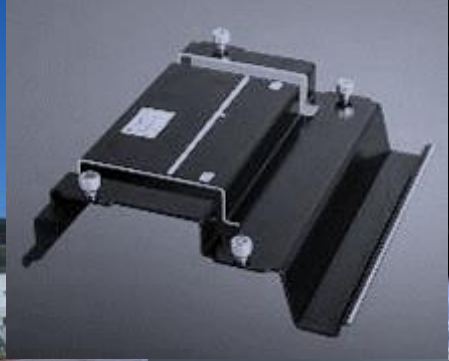

# 全球布局

2 strategic poles



EUROPE

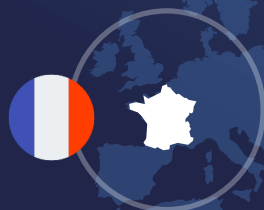

**AGILITEAM**  
BY JINPAO

JINPAO



BANGKOK



Year : 2023

ASIA

EUROPE



60M

10M

USD



1200

106



1

3



**營運分布**  
Key figures

Year : 2023



**40~42%**  
Aerospace



**45~47%**  
Tele-comm



**7%**  
Electronic



**2%**  
Food



**1%**  
Automotive



**1%**  
Health-care

**MANUFACTURE**

NCT Punching, Laser, Bending, 3/4/5 Axis CNC Machining, Stamping, Hard Tooling, Hydroforming

**SPECIAL PROCESS**

Anodizing, Chemical Conversion Coating, Primer & Painting, Powder Coating, Bonding Non-Destructive Testing, Welding, Heat Treatment,

**SPECIAL PROCESS SUBCONTRACTORS**

Boric Acid Anodizing, Sulfuric Acid Anodizing, Hard Anodizing, Chromate Conversion, Electroless Nickel Plating, Chrome Plating, Nickel Plating, Cadmium Plating, Silver Plating, Bronze Plating, Tin Plating, Zinc Plating, Passivation, Heat Treatment, Die Casting



**1%**  
Energy

**競爭優勢**  
價值整合

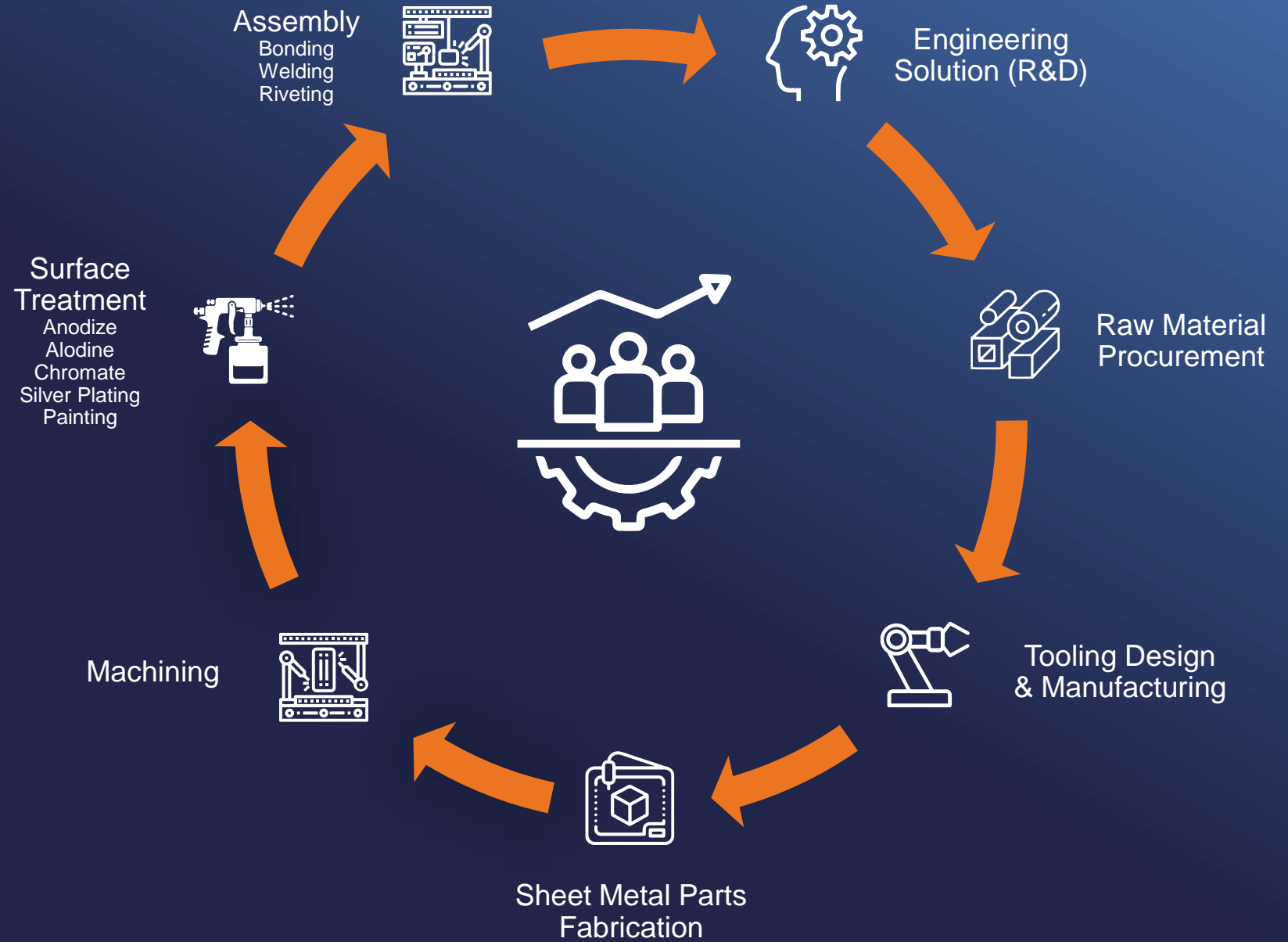

**MATERIAL TYPE**

Aluminum, Stainless Steel,  
Inconel, Copper Alloys,  
Nickel Alloy, Titanium

Plate, Sheet, Bars, Extrusion, Die  
Casting

製造工藝  
Processes

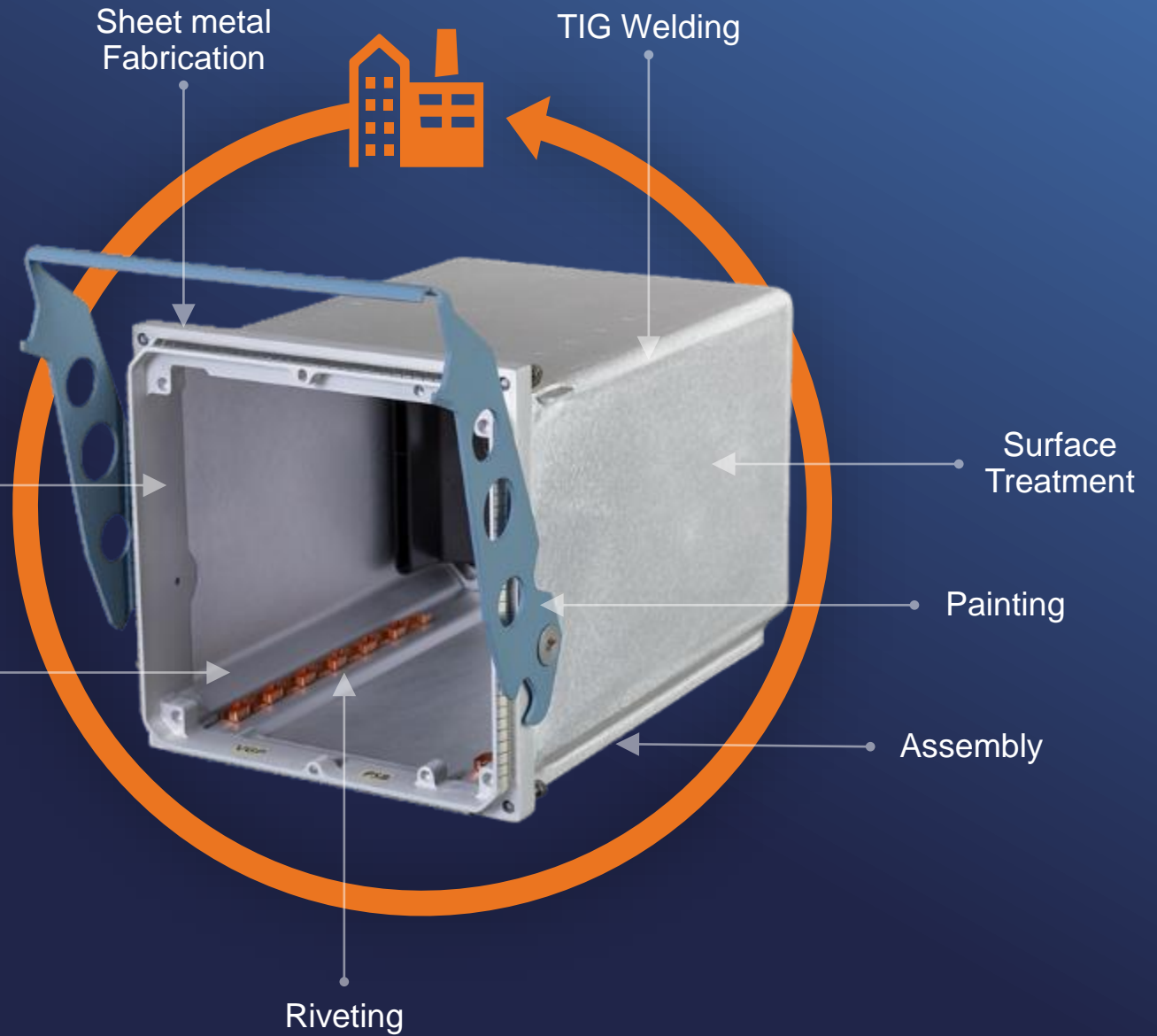

OUR CERTIFICATIONS



New





**YOUR global partner**

Custom Mechanics  
High-Mix  
Low-Volume

今年展望

今年重點目標 **Non-Aerospace**  
明年重點目標 **Aerospace**



**YOUR global partner**

Custom Mechanics  
High-Mix  
Low-Volume

航太産業







# 現有專案機型

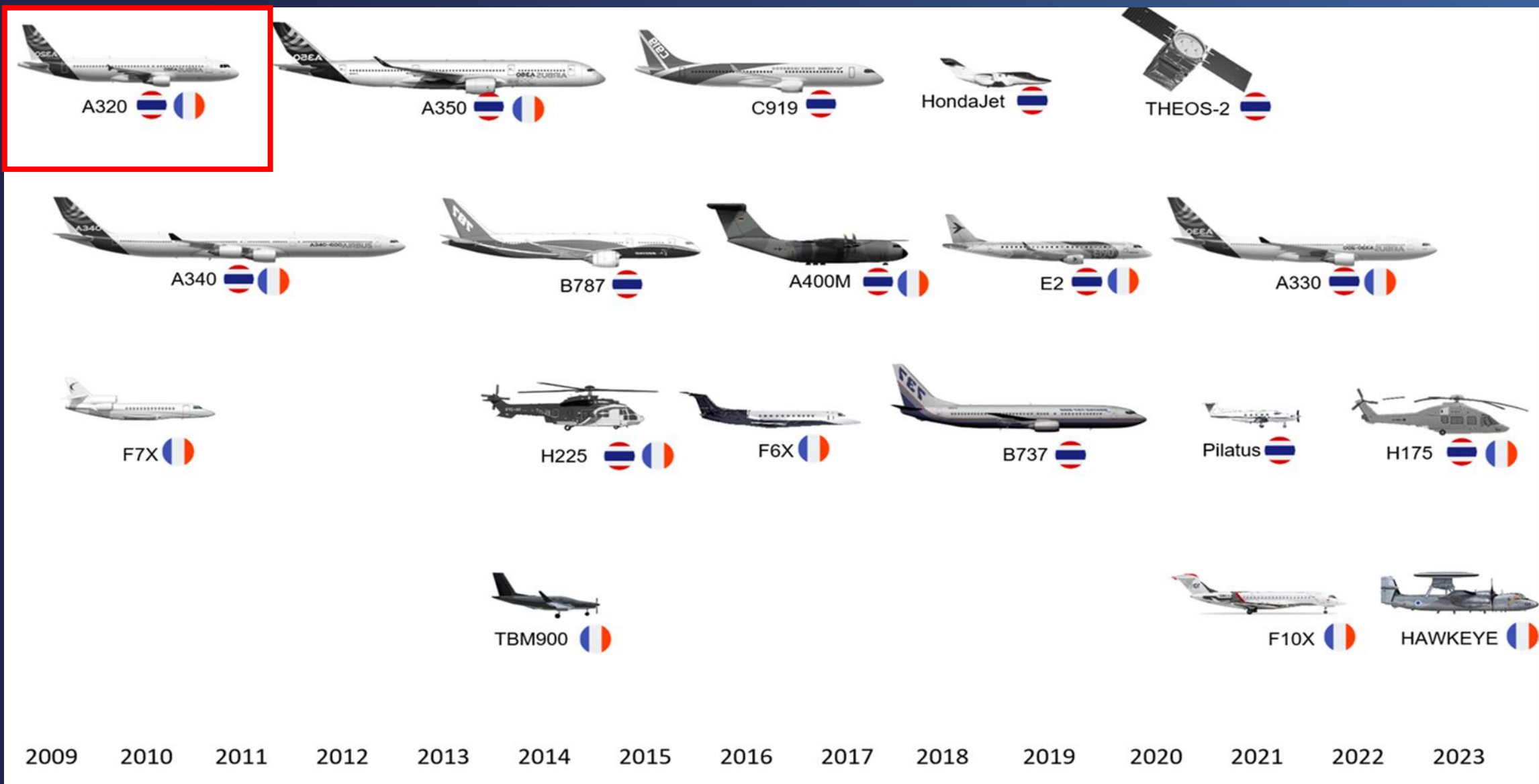

# 單走道客機生產計劃

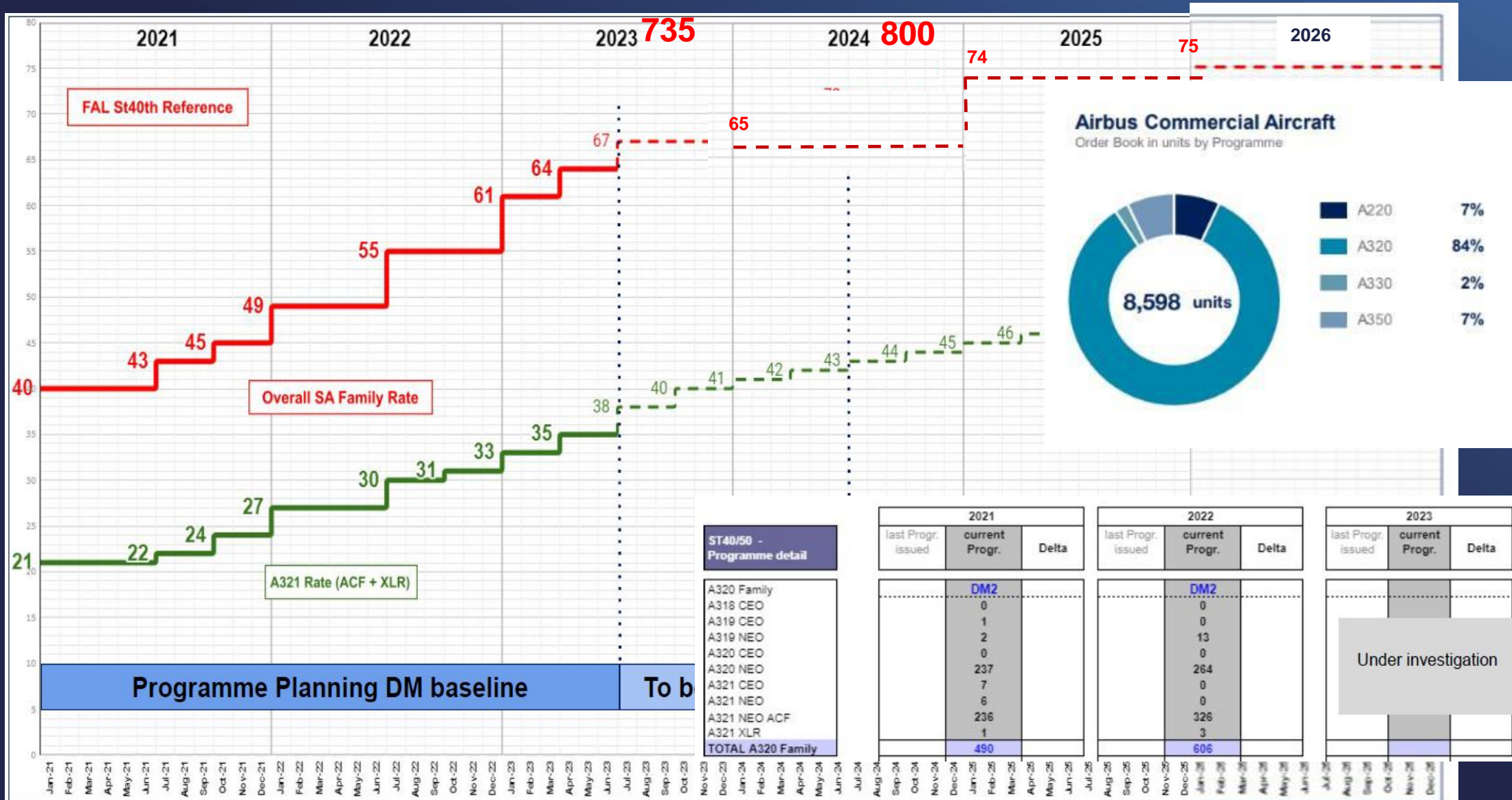

**Aerospace**  
新機製造



**A340**

**Aerospace Products**



**A320**



## Aerospace Products

# Electrical Flight Control System Computers Enclosures

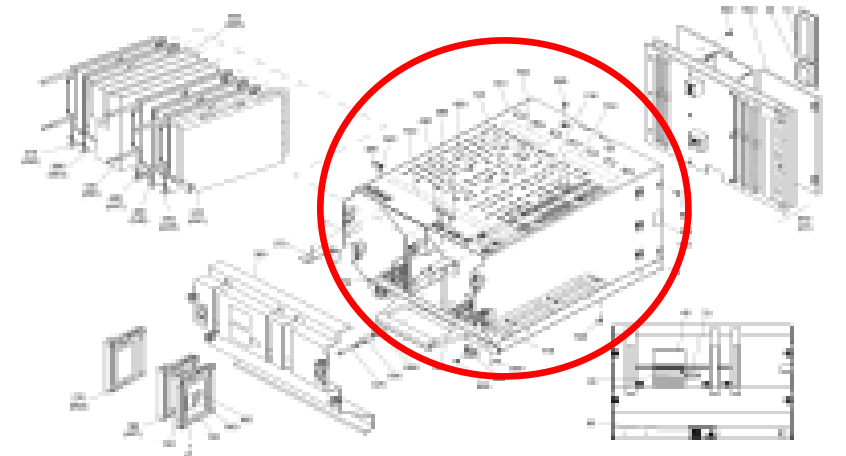
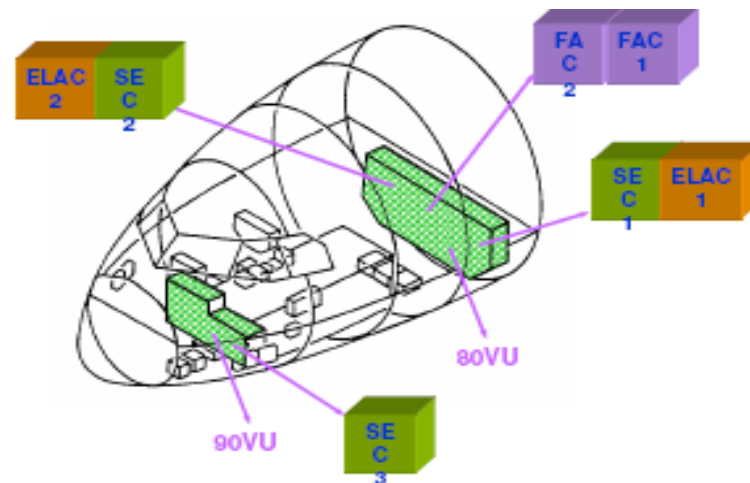

## Aerospace



Totally JINPAO  
produce 56 different  
part numbers for  
A350



Transformer  
Rectifier Unit

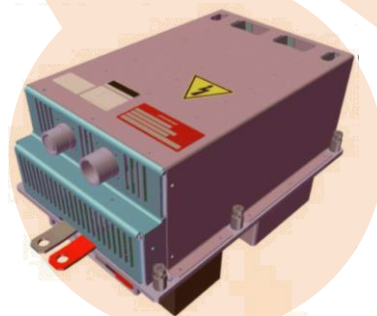

Regulated  
Transformer  
Rectifier Unit



Auto  
Transformer  
Unit



Electrical Flight  
Control System  
Computers  
Enclosure

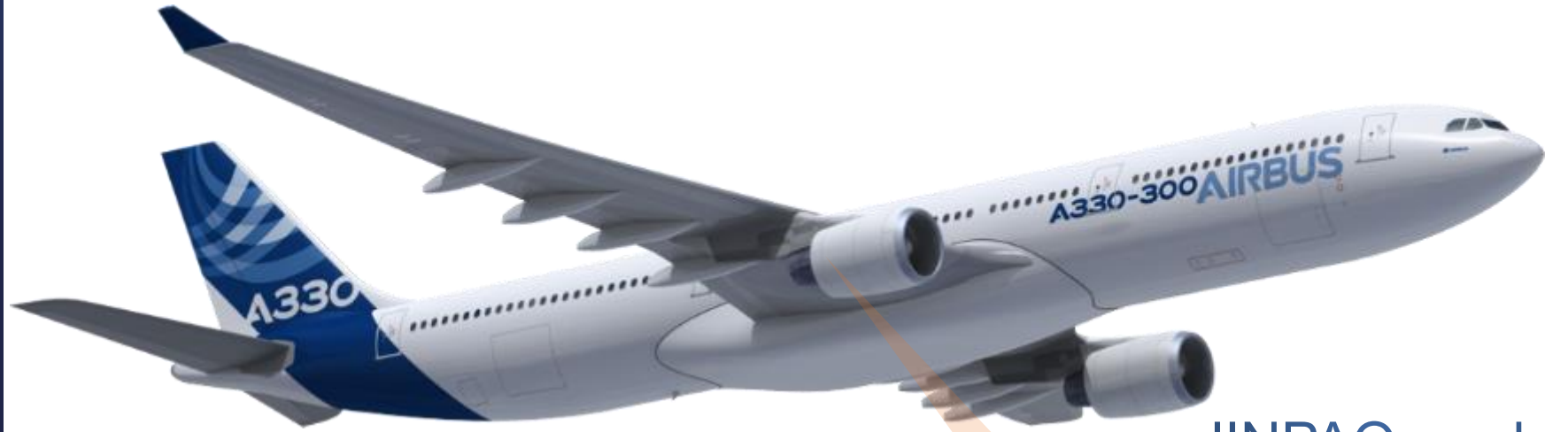

JINPAO produce  
sheet metal parts  
for airplane  
engine

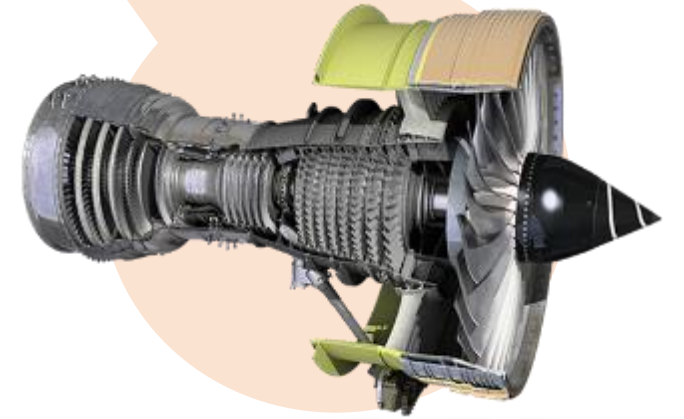

Trent-700 (Rolls-  
Royce)



THEOS-2

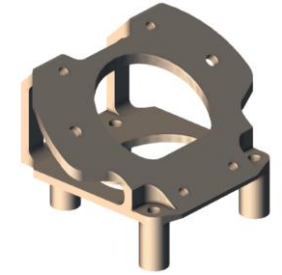
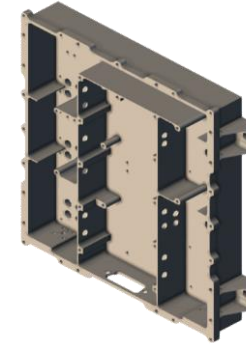
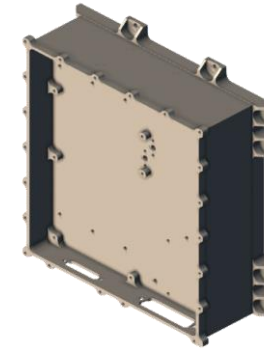
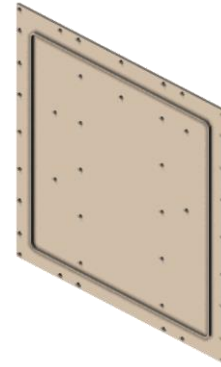
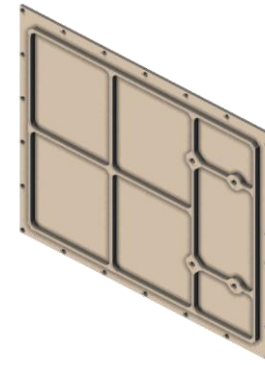

Star Tracker  
Interface Bracket  
(Titanium)

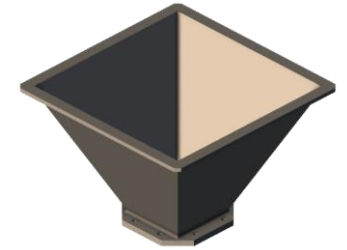

X-Band Horn  
Antenna (Aluminum)

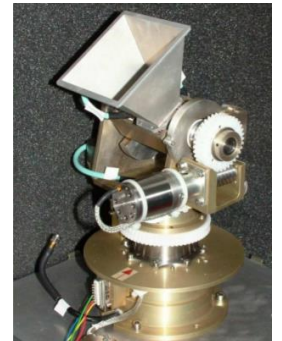





## 今年新客戶 及目標產品

- 1、座椅結構件
- 2、Airbus子公司合作

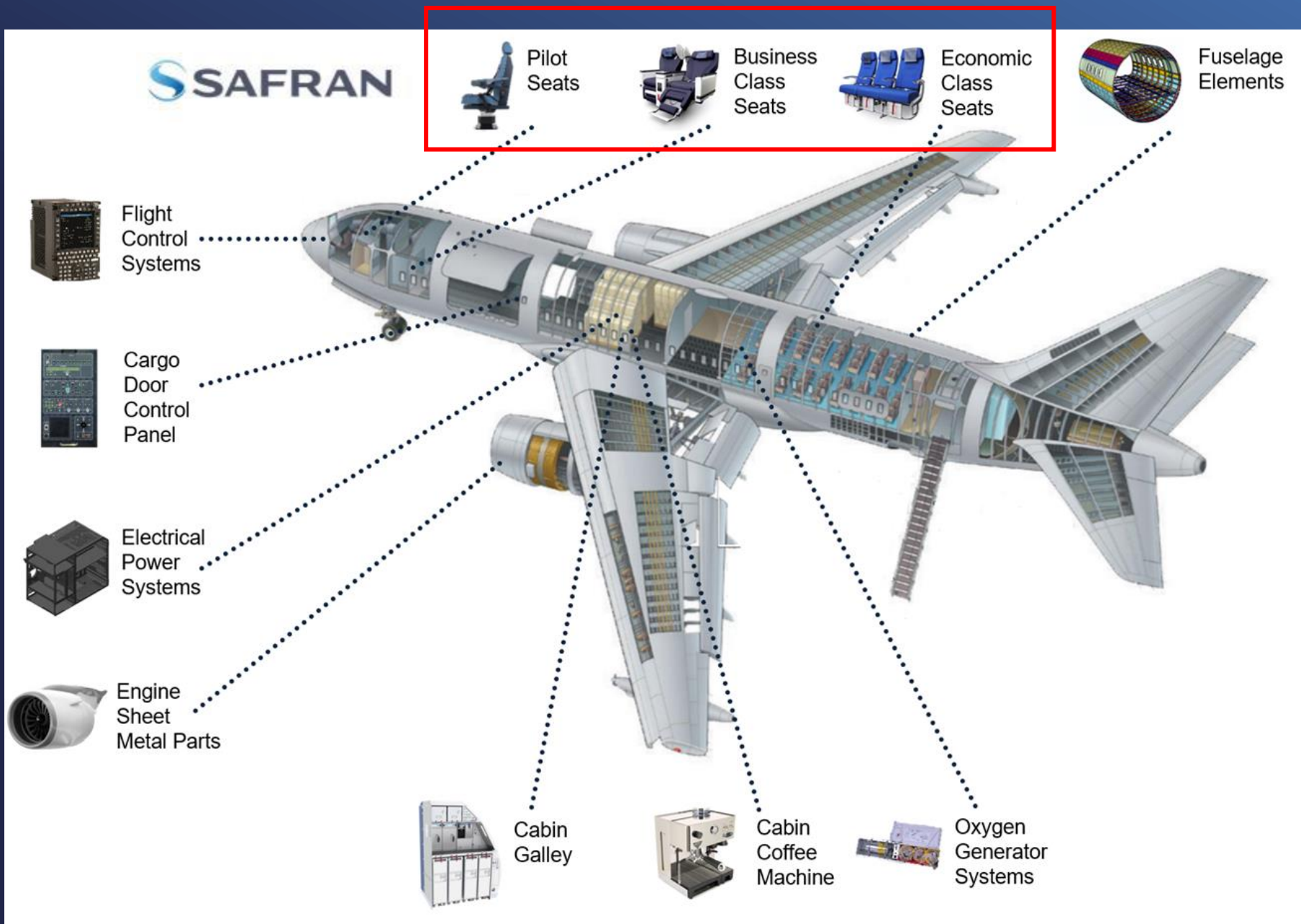

**MRO**  
維修改裝



## 維修改裝



Mordor Intelligence 預估 2023~2028 商用飛機 MRO市場將從742億美元規模成長至941億美元，複合年均成長率4.88%

## 歐洲子公司

今年營運暢旺  
目標100萬歐元/月



經寶歐洲

ADB

(車床件)



LUTEC

(銑床件)



SPEM

(表面處理)





**YOUR global partner**

Custom Mechanics  
High-Mix  
Low-Volume

非航太產品



今年重點目標-**AI Server**  
明年重點目標-數位咖啡機

## Data Center

### -Rack

42U

48U

48U Open Rack

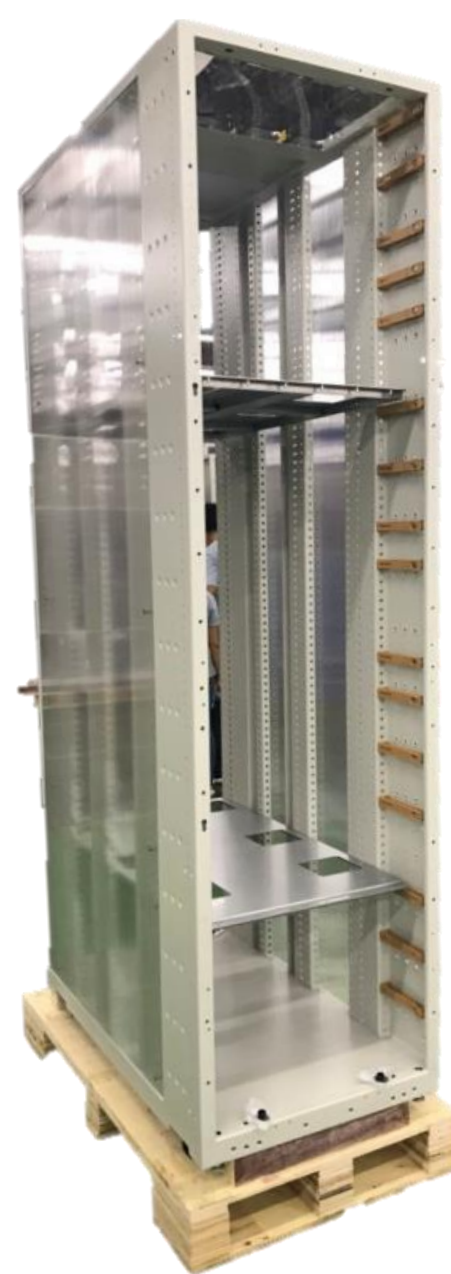

# Data Center

- Server Case  
1U~2U

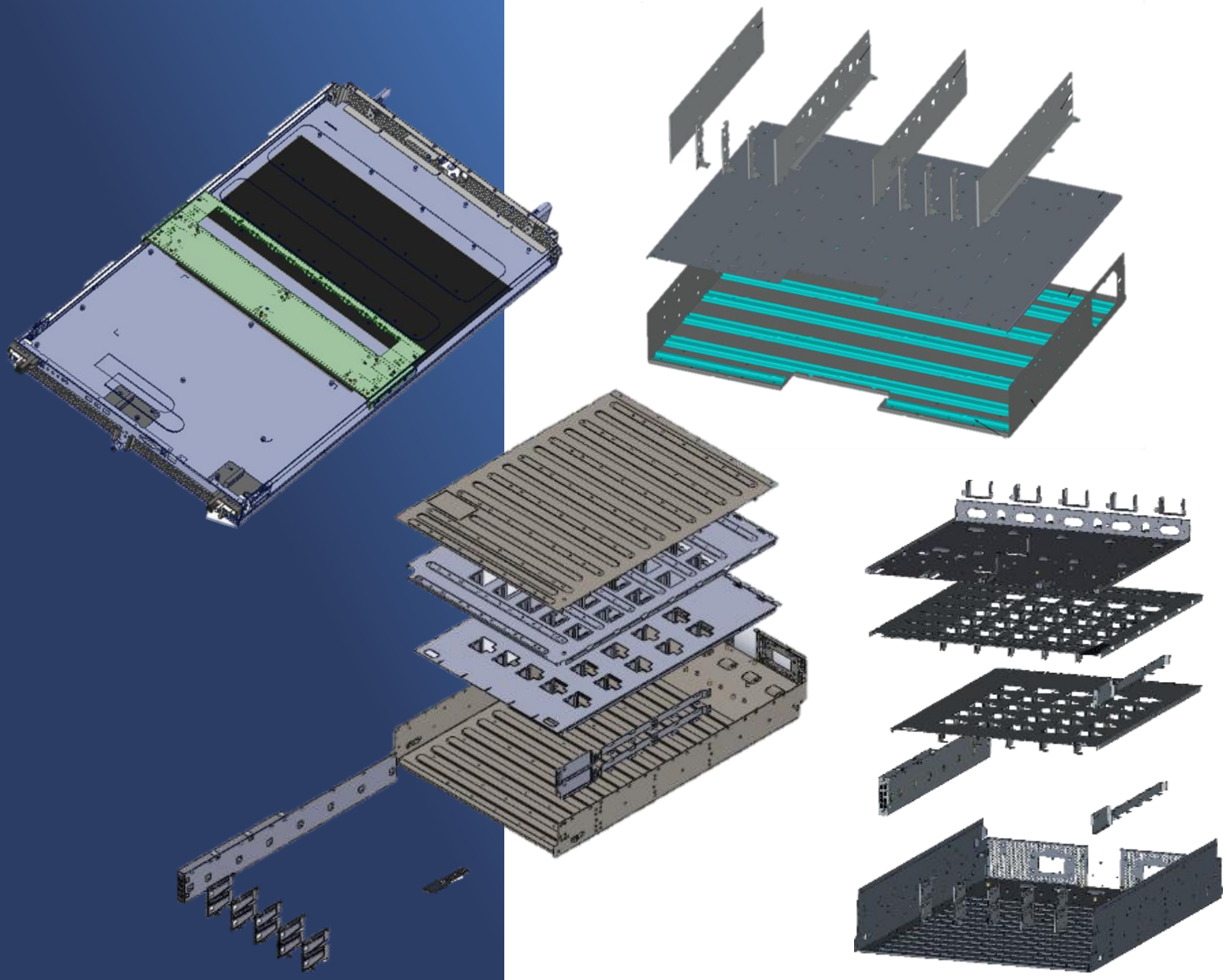

# Data Center -Manifold and Rack (Front Side)

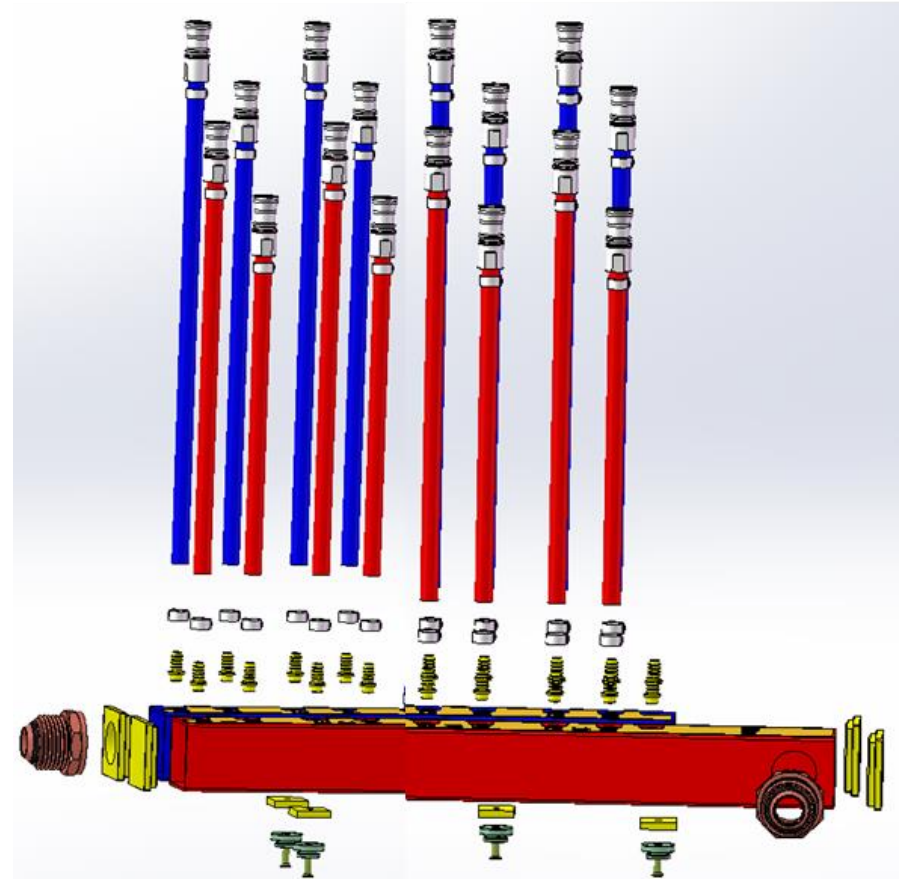
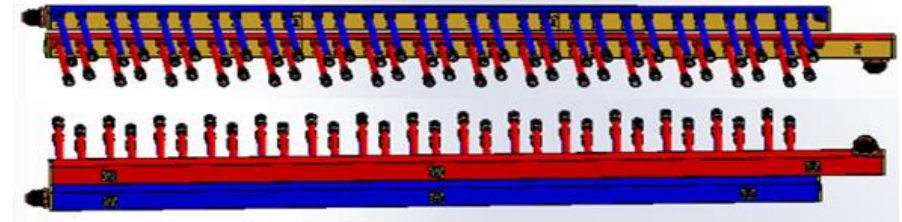



# Data Center

-Manifold and Rack  
(Back Side)

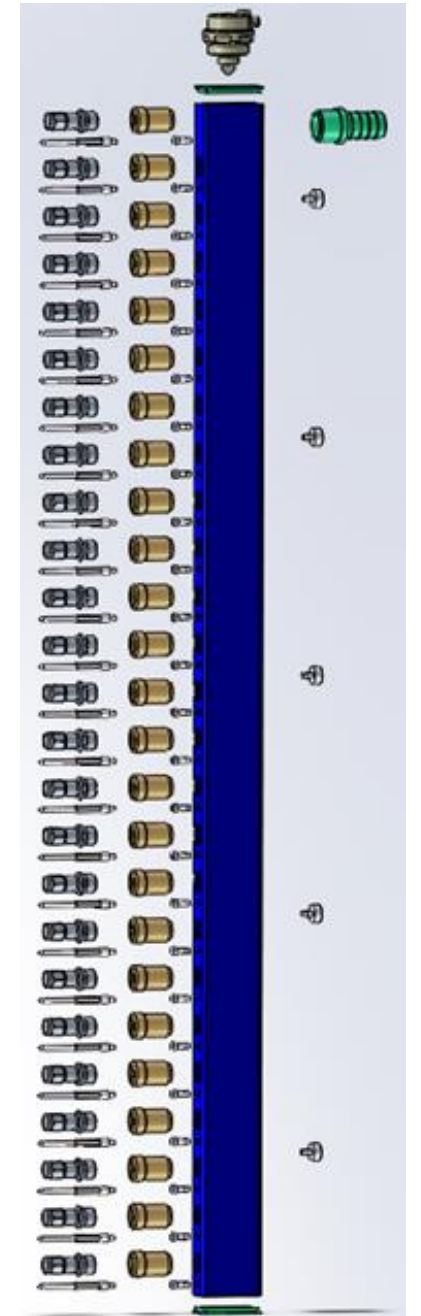
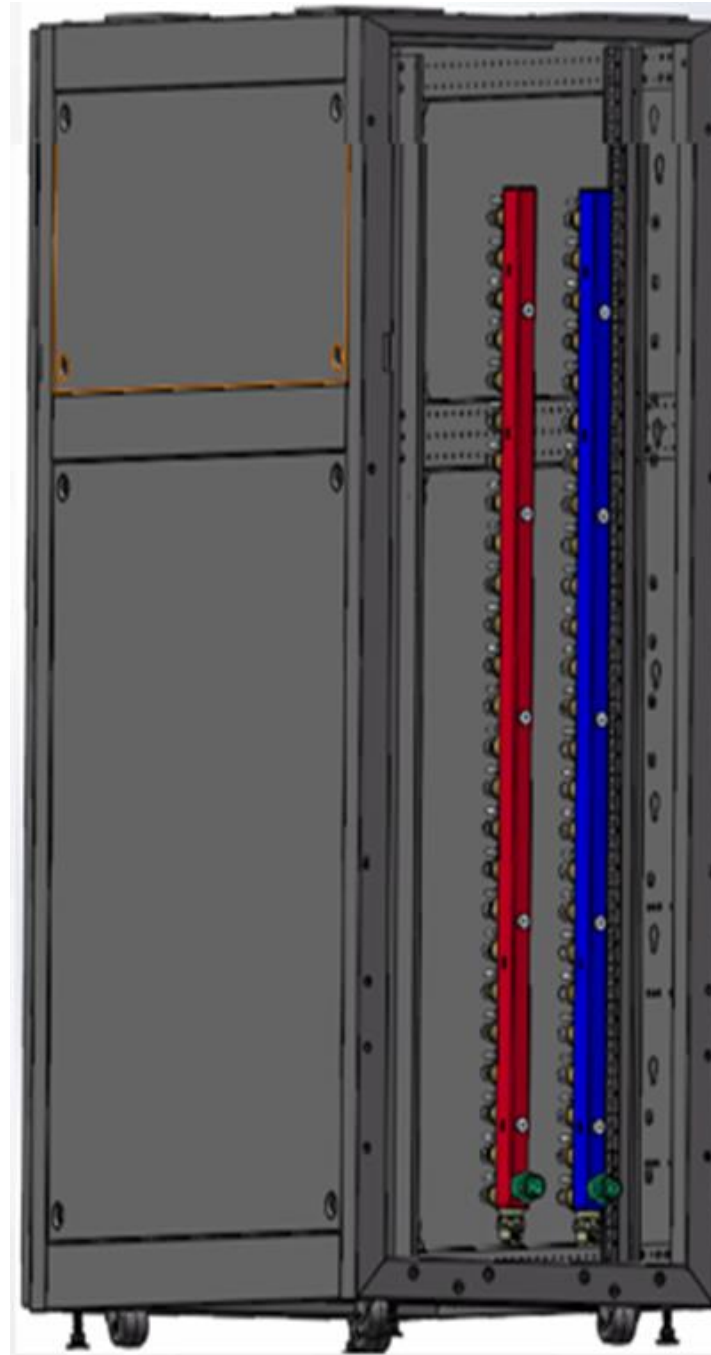

# Data Center

-Manifold and Rack

(Top Side)

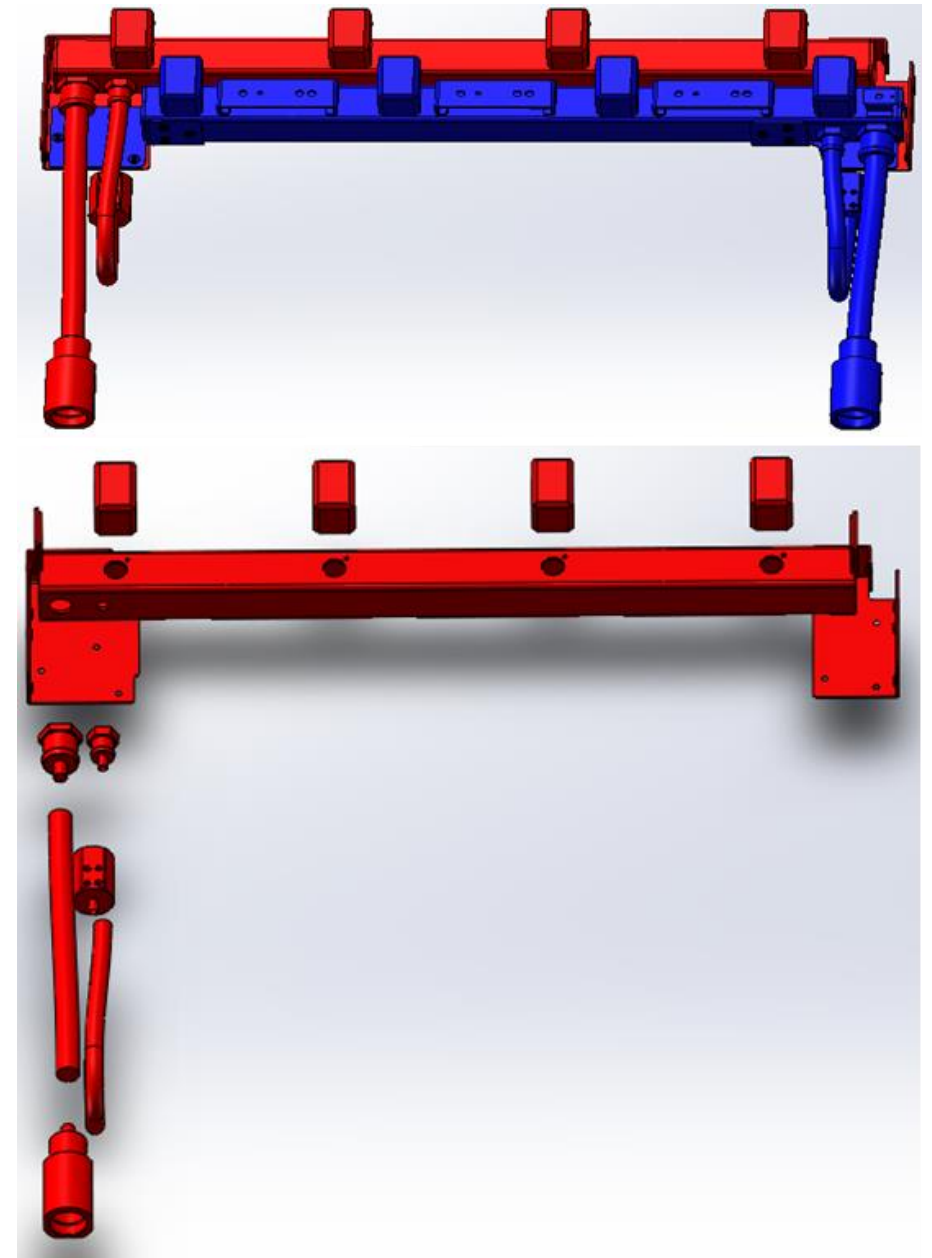
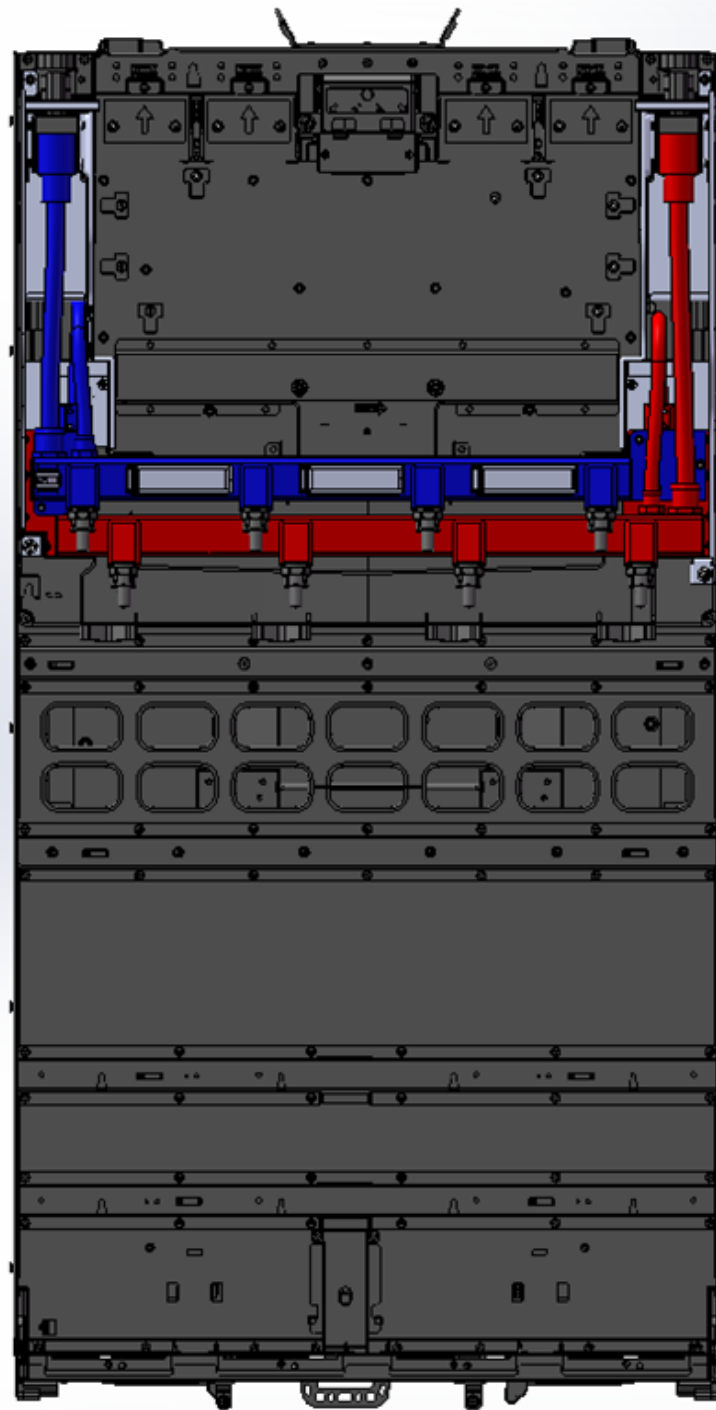

# 智慧醫療

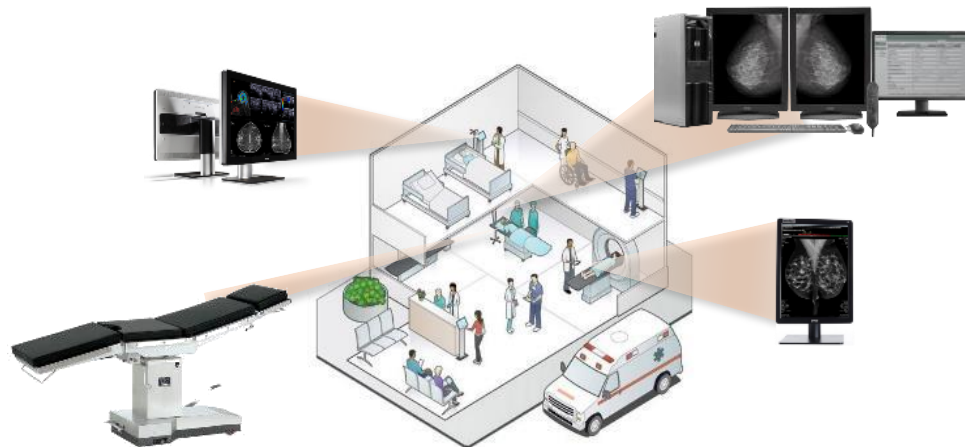

## 食品工業



### TECHNOLOGY AND FOOD SAFETY

JINPAO provide manufacturing of equipment for Automotive industry, included:

- food scanners
- vending machines
- X-Ray Metal Checker
- Automatic Combination Weightier
- Milk Analyzer



# 數位咖啡機 Taobin



# 工廠產能規劃



航太廠



非航太





非航太



**2023**  
**新建電鍍研磨廠**





## 未來規劃

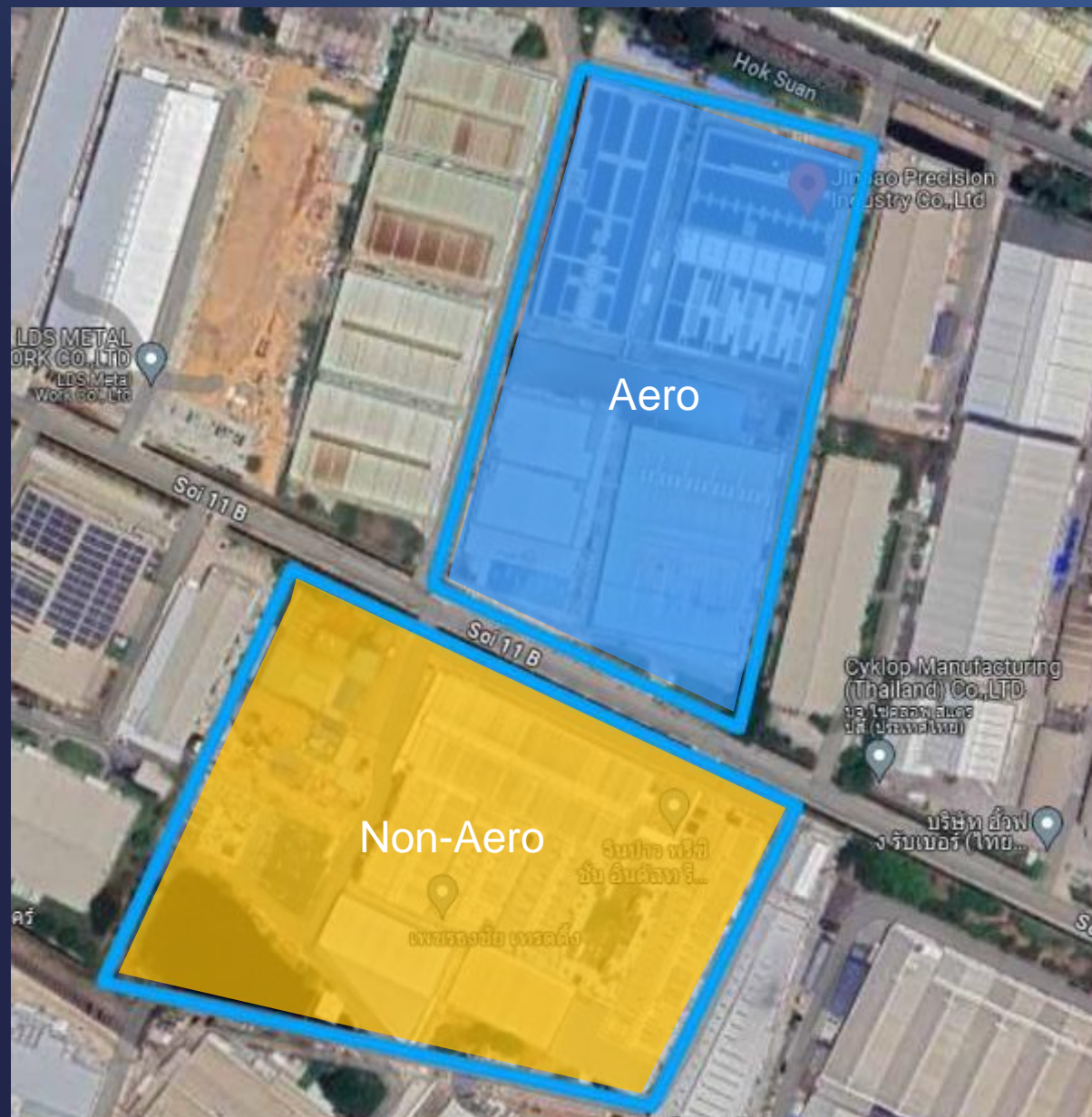



**THANK YOU**