

TWSE:5284 jpp-KY

JINPAO

# 經寶精密(控股)股份有限公司



# 工廠外觀



# 廠區照片



# 生產基地

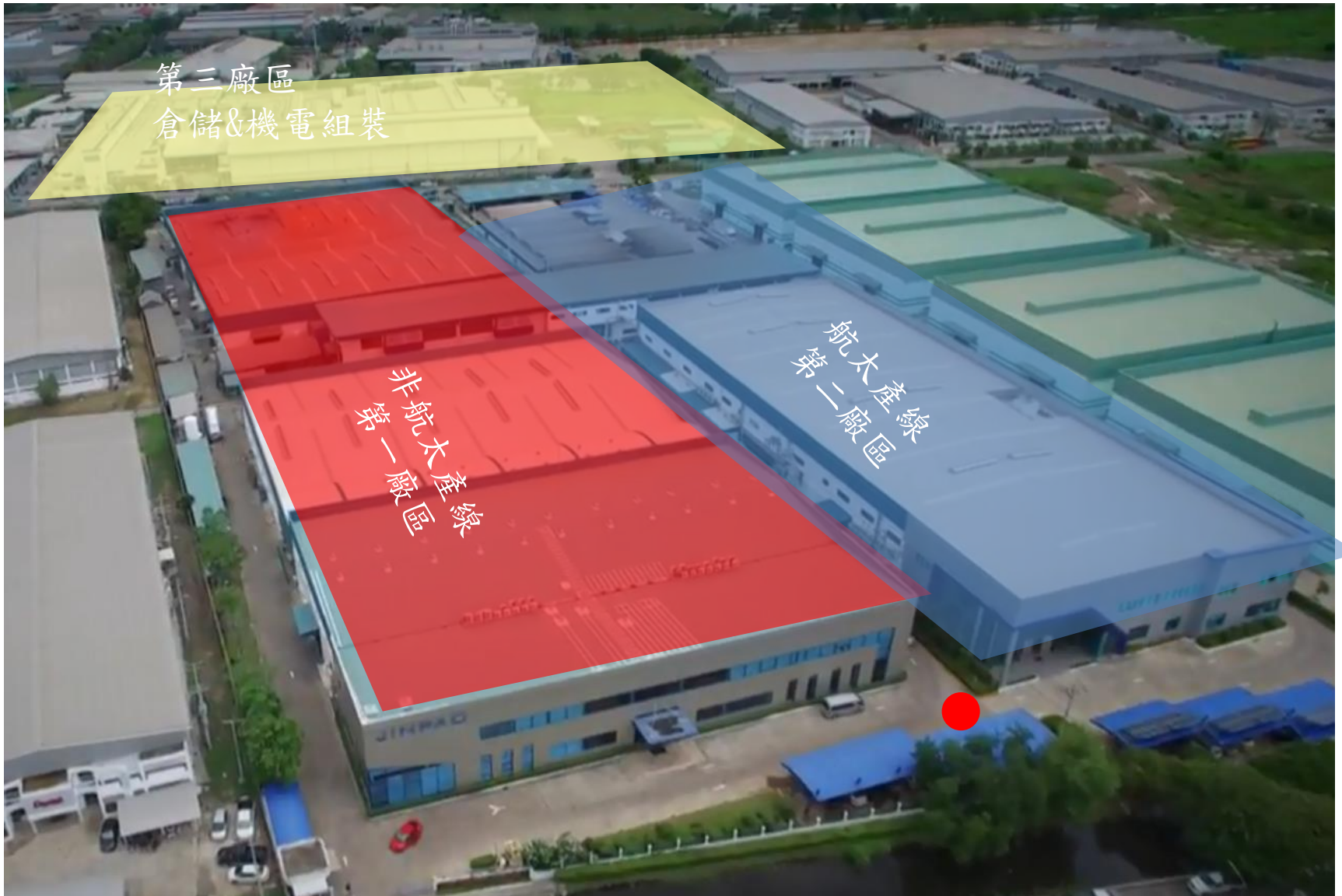

# 衛星圖



第三廠區

49,297m<sup>2</sup>

第一廠區  
第二廠區

39,228m<sup>2</sup>

人數 1150 人

資本額 NTD 4.79億

現有廠地面積 88,525 m<sup>2</sup>

現有廠房面積 54,187 m<sup>2</sup>

# 地理位置



# 新購置土地位置

泰國EEC經濟特區  
- 鄰近國際空港/海港與曼谷市區, 運輸便利四通八達

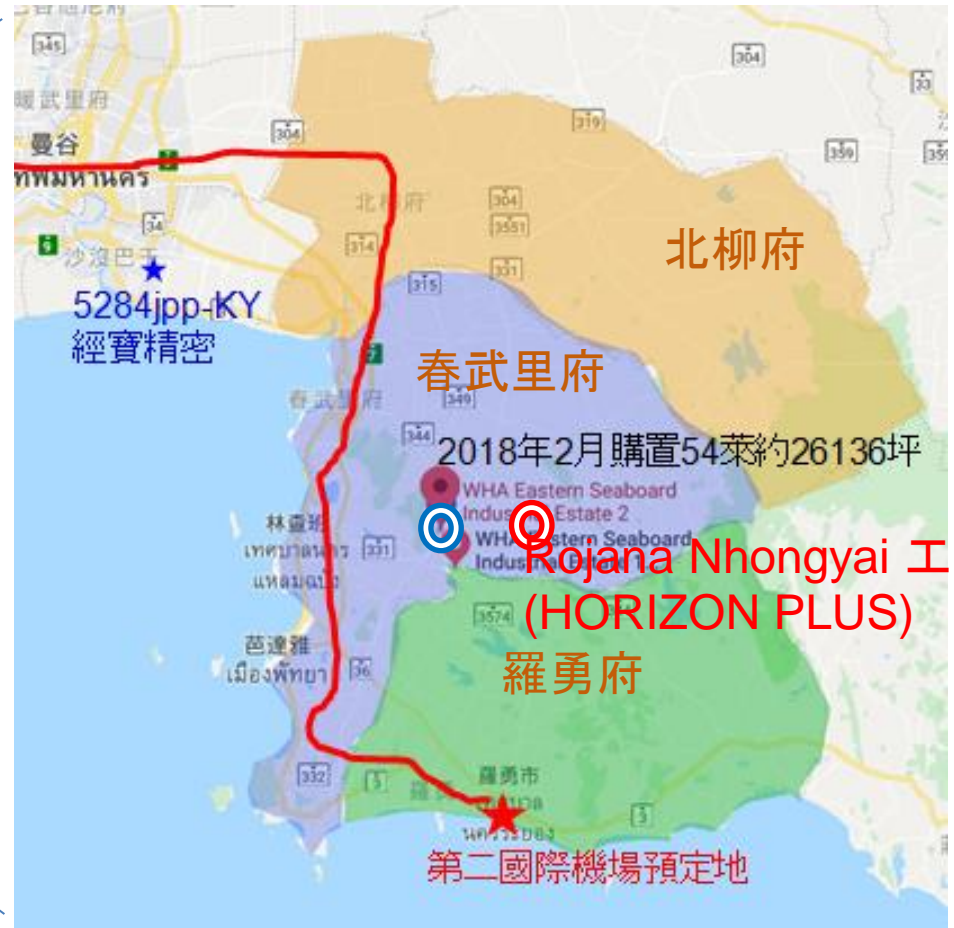





# 生產基地

## 全球化供應鏈服務

SPEM (France)



2020年初

LUTEC (France)



2018年底

ADB (France)





# 競爭優勢

# 地理優勢

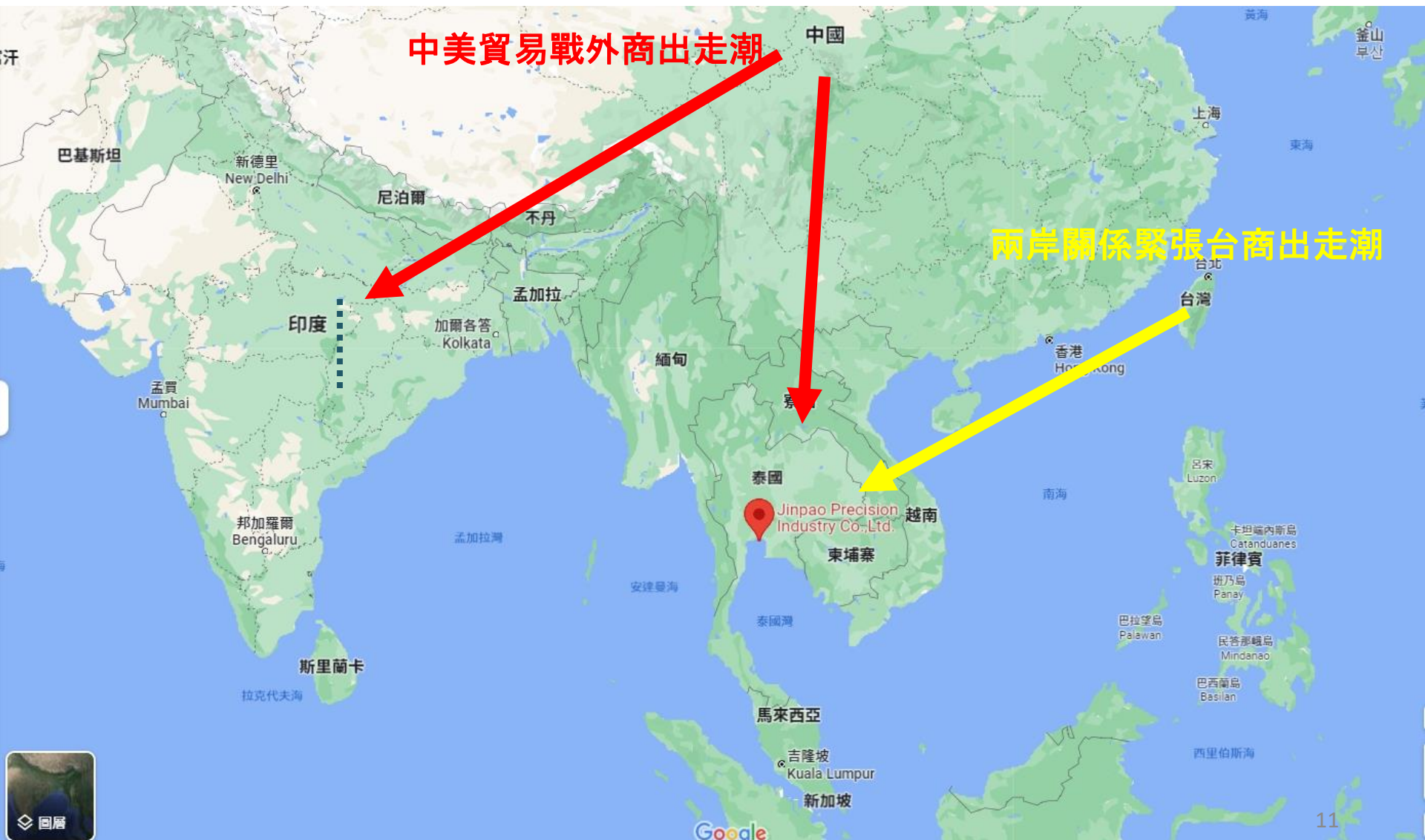

# 研發優勢

## 國際化團隊 - 降低與客戶間溝通上的隔閡

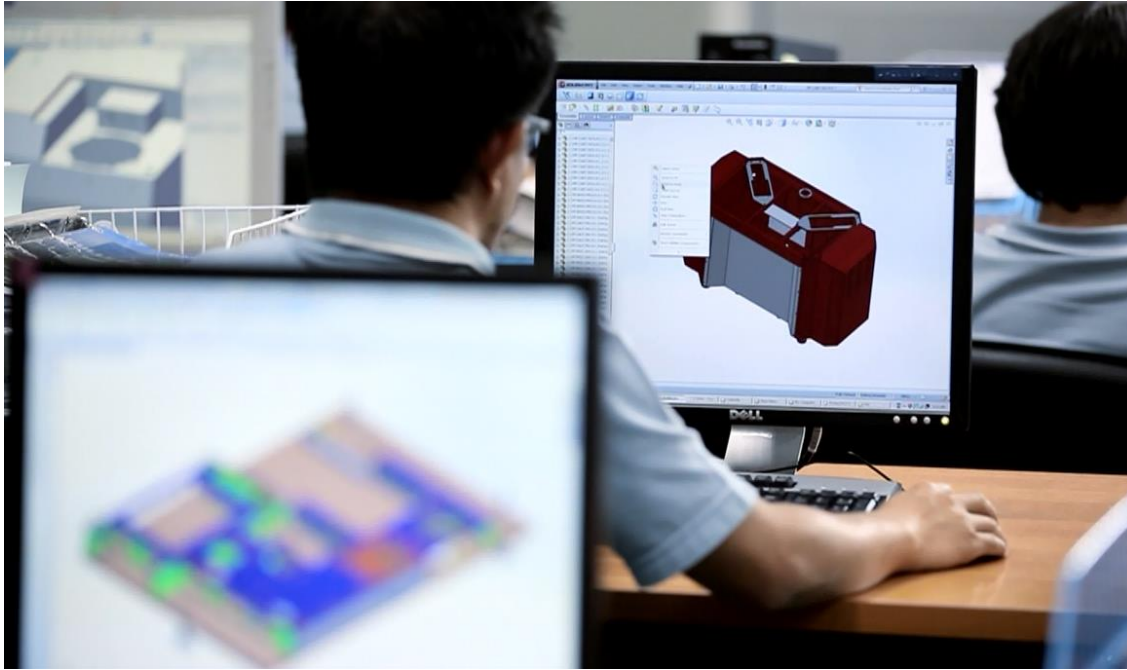

自主的研發能力  
提供客戶ODM或OEM的雙重選擇



HongKong



Thailand



Taiwan



Malaysia



Australia



Philippines



Japan



India



Russia

# 製程優勢

一站式製程服務-提供高競爭與完善的解決方案



**Punching**



**LASER**



**BENDING**



**TOOLING**



**STAMPING**



**MACHINING**

# 製程優勢

一站式製程服務-多家小工廠的集合體



WELDING



PAINTING



ASSEMBLY



Robot Clinching



SURFACE TREATMENT

## 一站式的解決方案(品質保證)

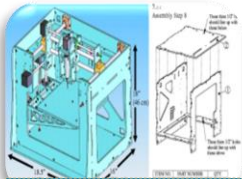

- 結構設計
- 3D 建模
- 2D 繪圖

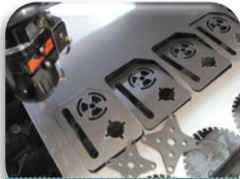

- 嵌套
- 雷射切割
- 沖孔

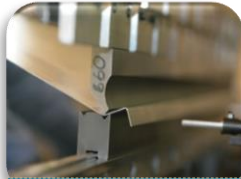

- 折彎

多樣少量客製化 (電腦沖床生產)

大量 (開模生產)

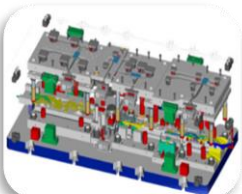

- 硬體設計
- 3D Modeling
- 2D Drawing



- 模具製造



- 沖壓

以最先進的工藝技術為客戶提供從代客研發設計到製造的一站式解決方案(全製程)



- Welding
- Spot Welding



- Chromating



- Powder and Liquid Painting
- Silk Screen



- Assembly

# 彈性優勢 客製化兼具大量生產

## 彈性製造能力 (Build to Order)

精密機  
構件的  
解決方案及代  
客研發  
設計

客製化產品：

→ 產量特性：少量多樣

大量客製化：

→ 結合NCT及開模生產

經濟規模產品：

→ 產量特性：大量生產

NCT

電腦沖床加工

模具

開模量產

表面處理  
組裝  
焊接



開模



研發



CNC製程

大量規格化



沖壓



雷射切割

少量客製化



熔接



五軸CNC



折彎



清洗



噴漆



品管



高功率熔接



檢測



組裝



包裝



# 彈性優勢 快速反應能力

客製化的瓶頸在於少量生產時各部門間配合  
本公司透過無紙化及大數據應用，加強系統整合  
達到不同製程間快速反應能力



文件數位化



製造執行系統



工站執行監控

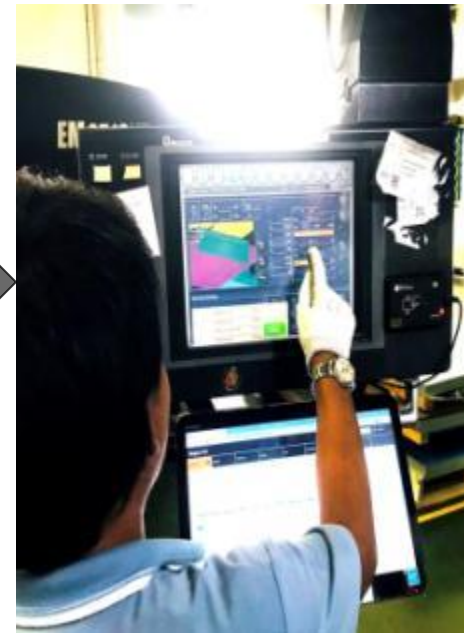

作業執行管理

# Jinpao Mini 4.0

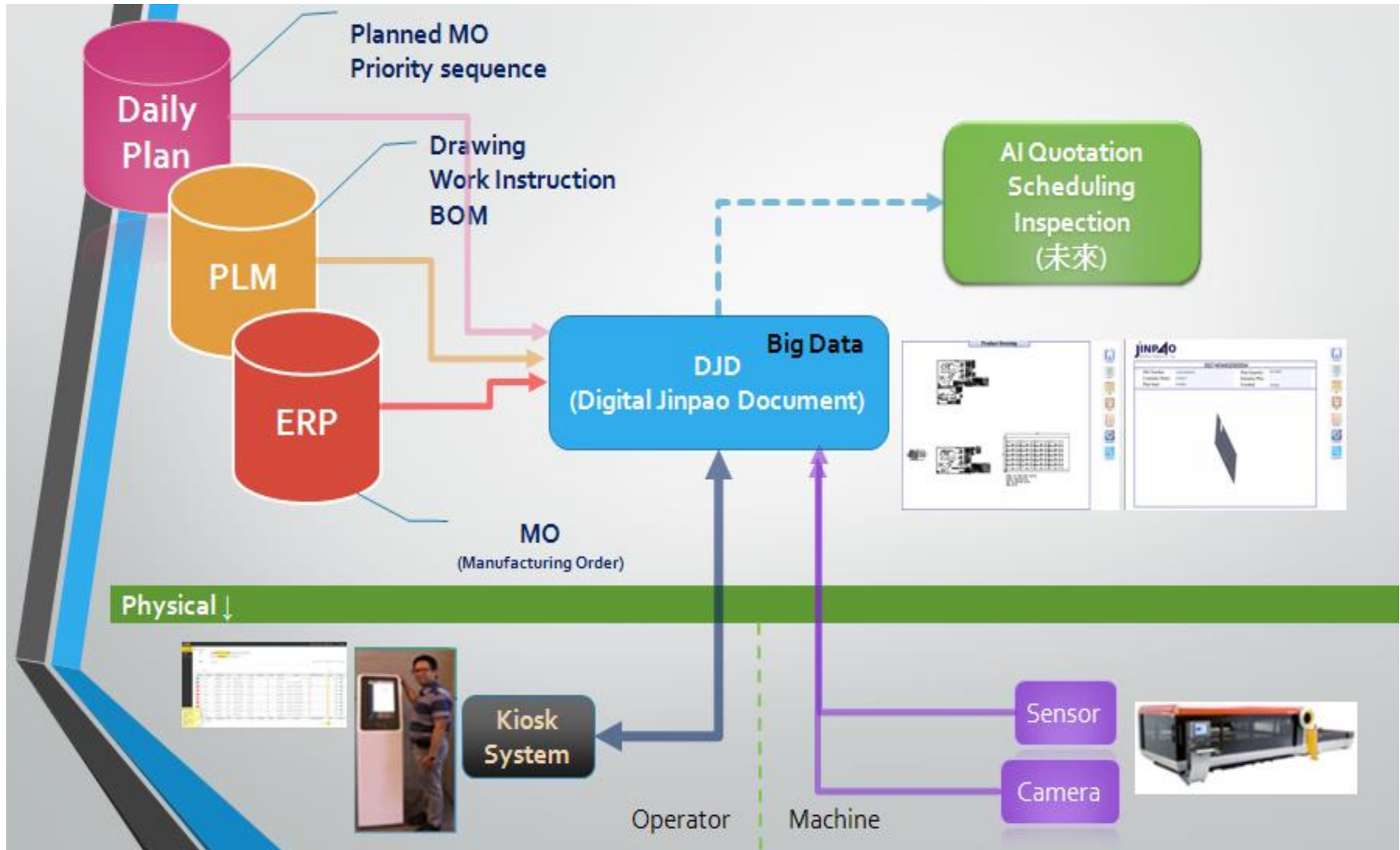

# 品質優勢 航太工藝技術

亞洲先進的鋁熔接技術，2016年取得  
泰國第一張美國航太Nadcap-Welding認證

**Robot Welding  
(Before)**



**Laser Welding  
(After)**





# 產品總 產出線



通訊 電子

航太

其他

5G

4G

無人商店

大數據



通訊類產品物聯網

# 通訊類產品

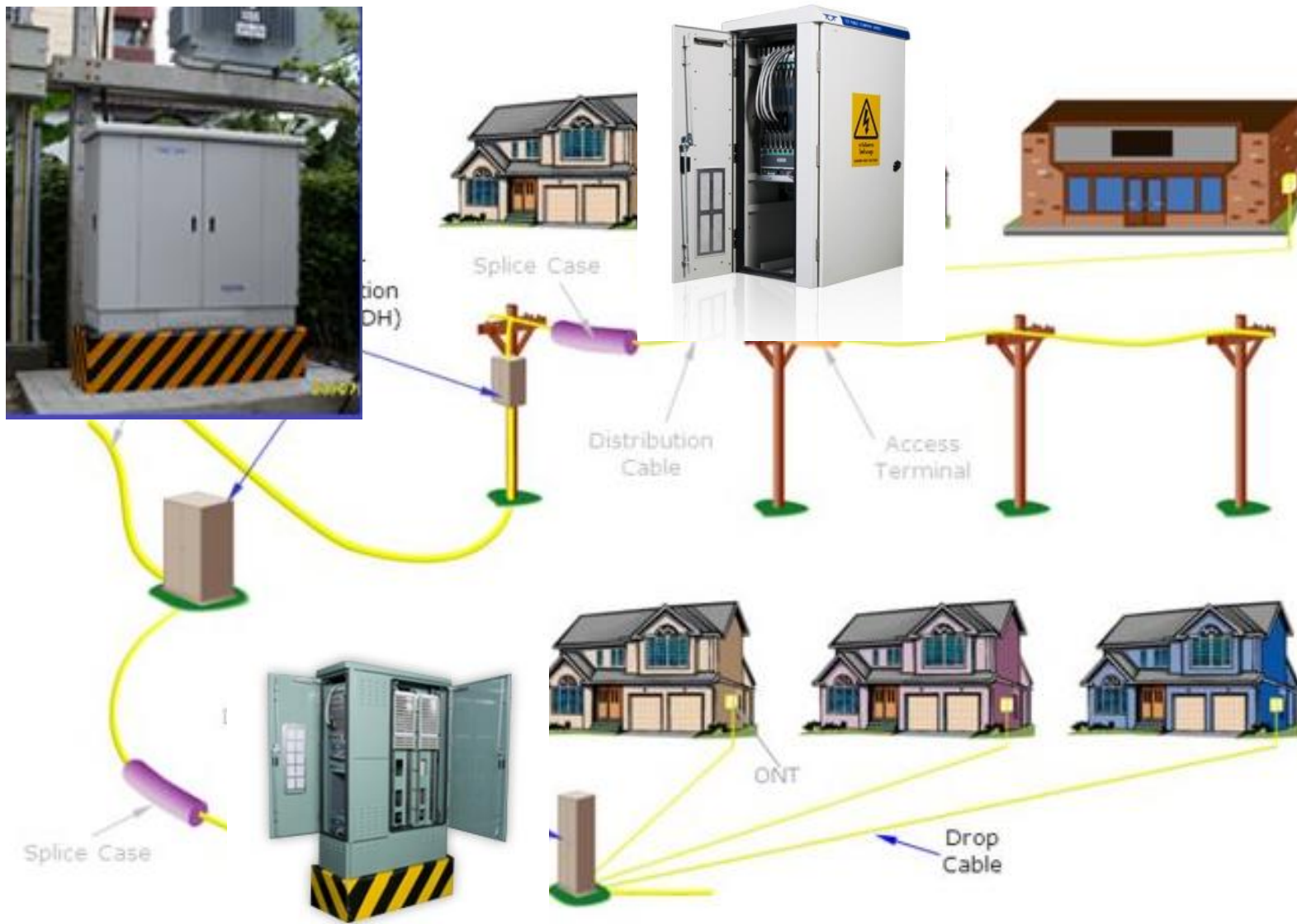

# 通訊類產品

## 泰國四大電信商認證





# 特殊規格設計

散熱、防腐、抗潮，內外溫差2度



# 數位加值機



# 自動販賣機

客製化自動販賣系統

整合  
第三方支付

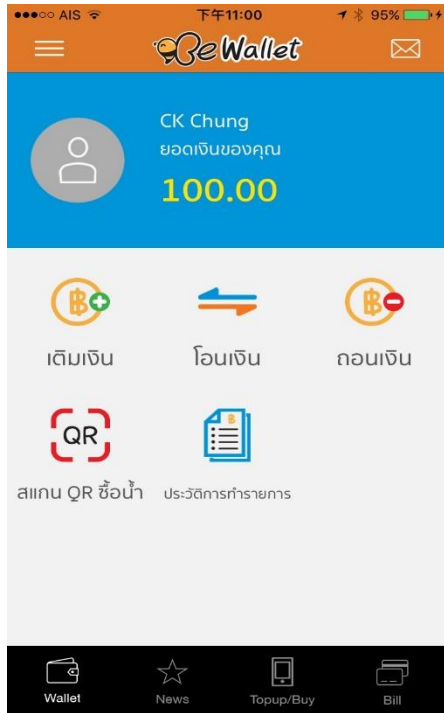

# 自助式儲物櫃



# 商用伺服器



*IP - 3000*  
Enterprise PBX



**FORTH**  
BUSINESS COMMUNICATION SYSTEM

The complex block features a background of three server racks and a network switch. The text "IP - 3000 Enterprise PBX" is prominently displayed in a stylized font. The FORTH logo, which includes a globe icon, is positioned at the bottom right of the block.

# 商用伺服器

## Storage system 1 ~ 11U



# 光纖通訊色散補償模組

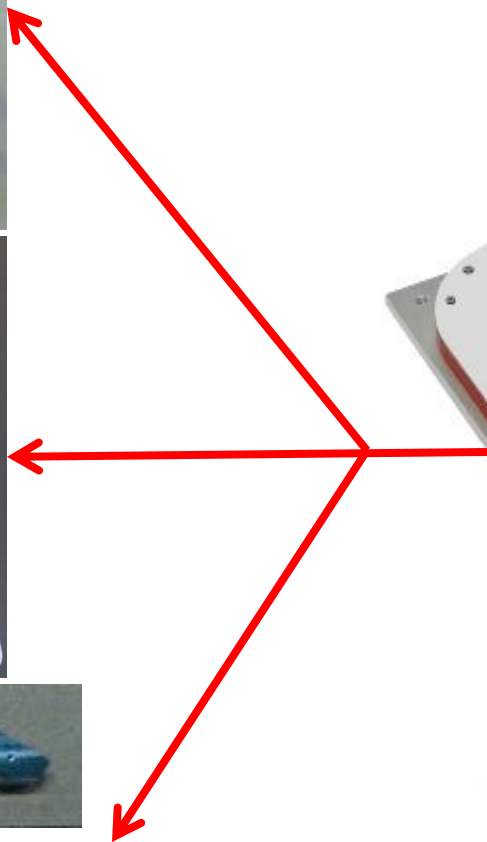
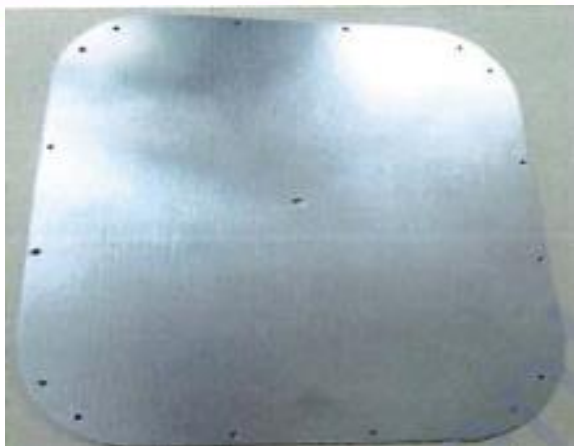

# 衛星通訊設備







# 電子類產品

# 3D列印機

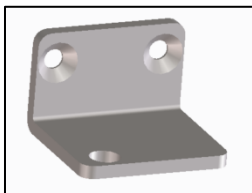
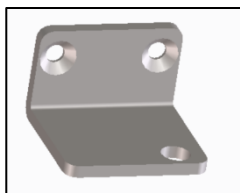
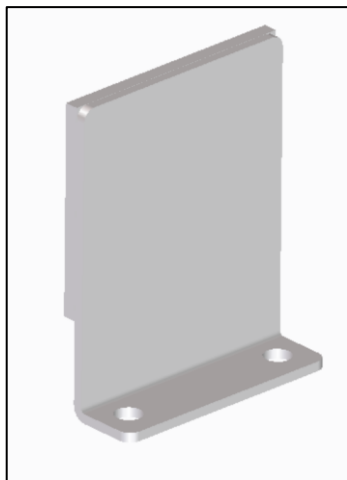
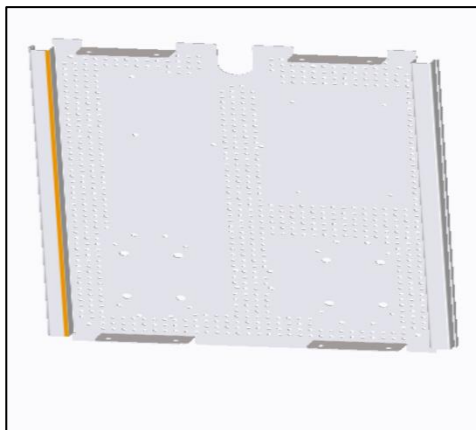
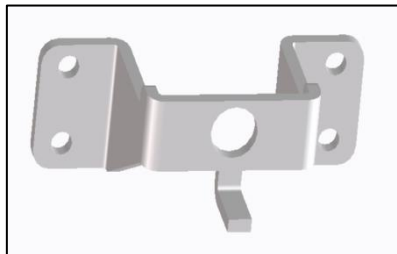

# 3D列印機

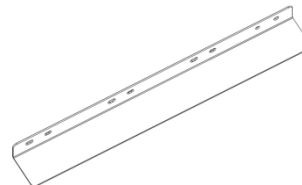
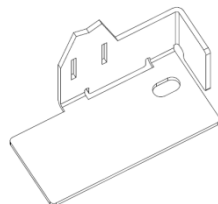
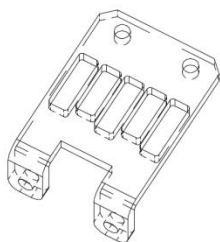
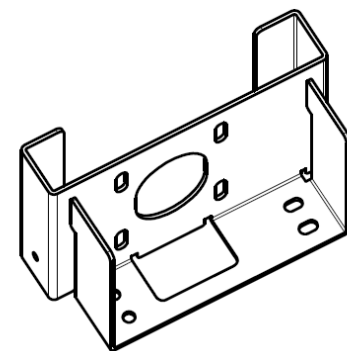
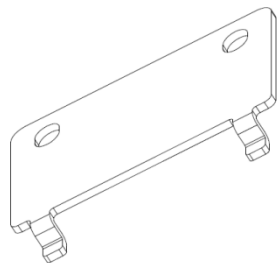
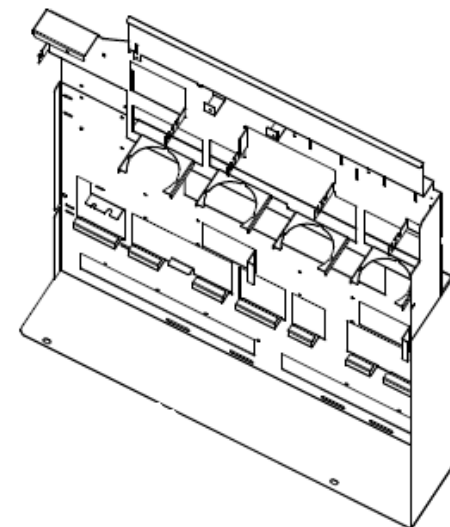
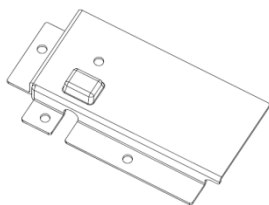
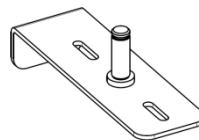
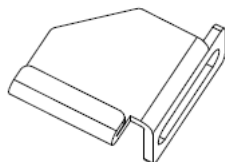
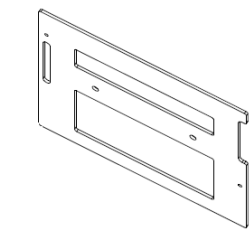

# 3D 列印機

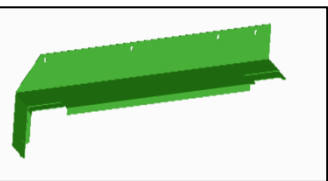
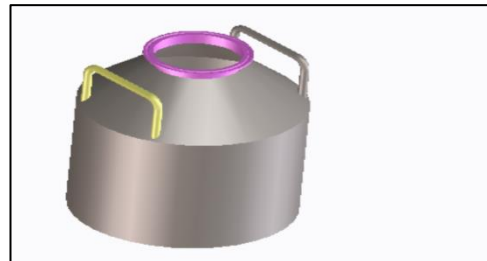
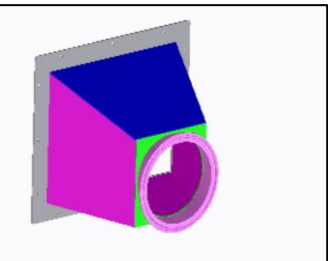
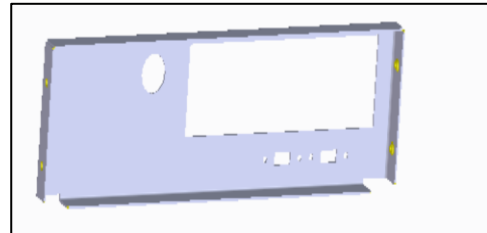
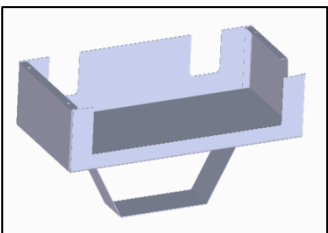
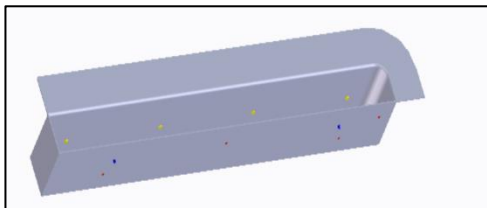
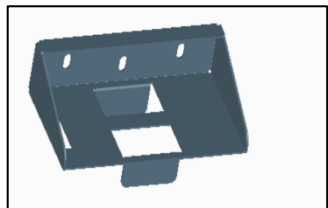

# 3D列印除粉回收裝置

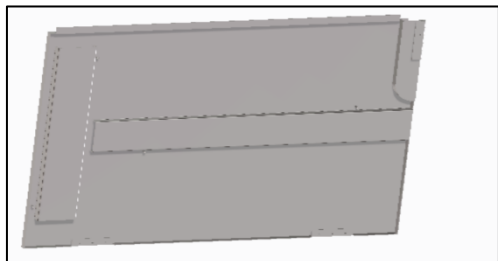
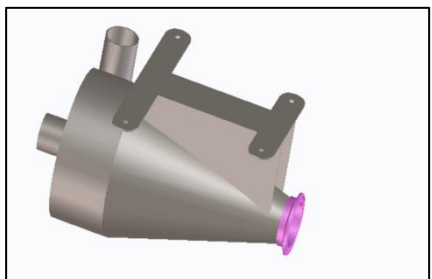
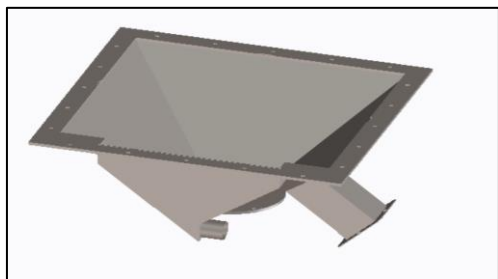
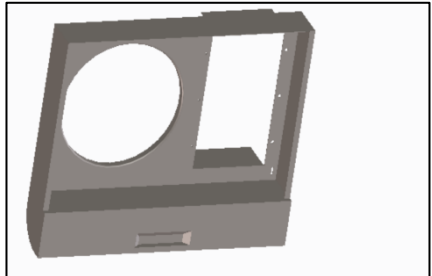
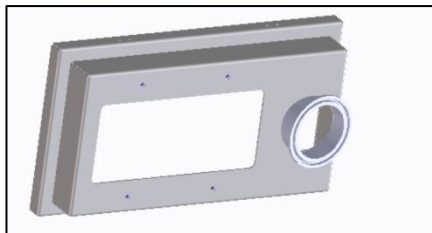
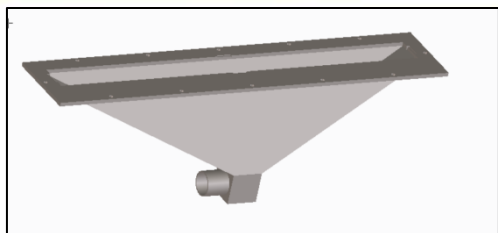

# 工業用印表機

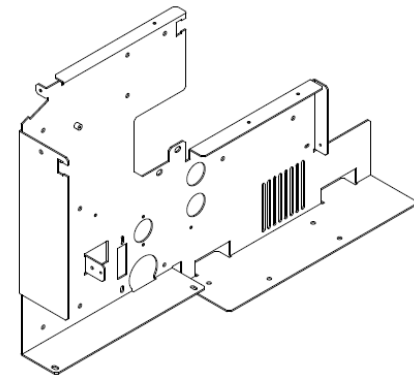
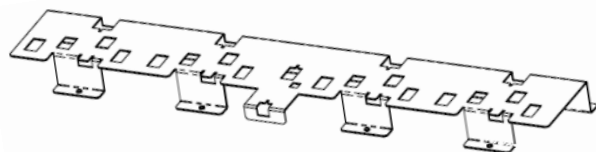
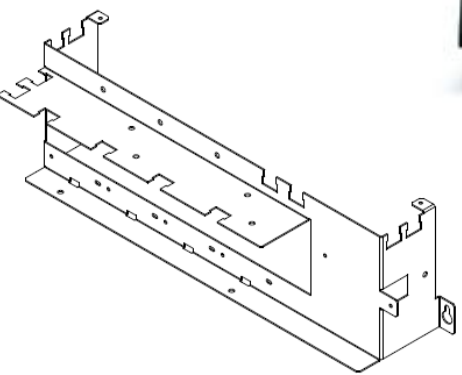
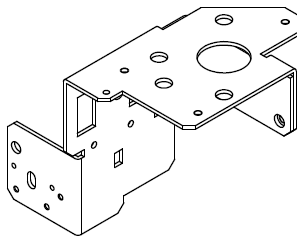
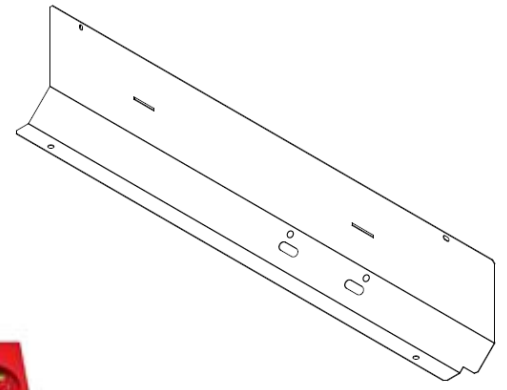
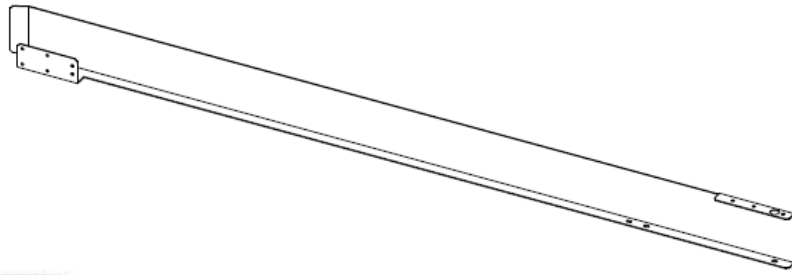
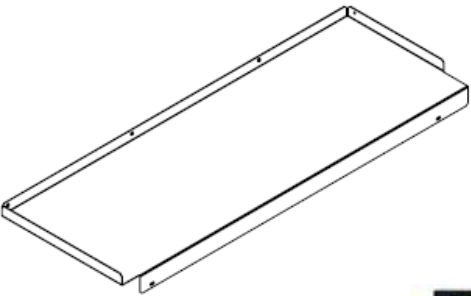

# 光纖雷射加工設備

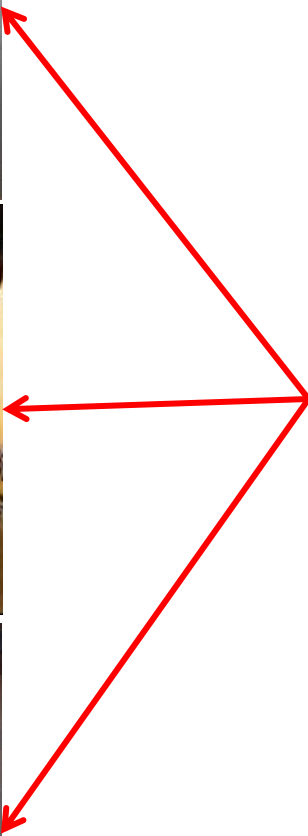
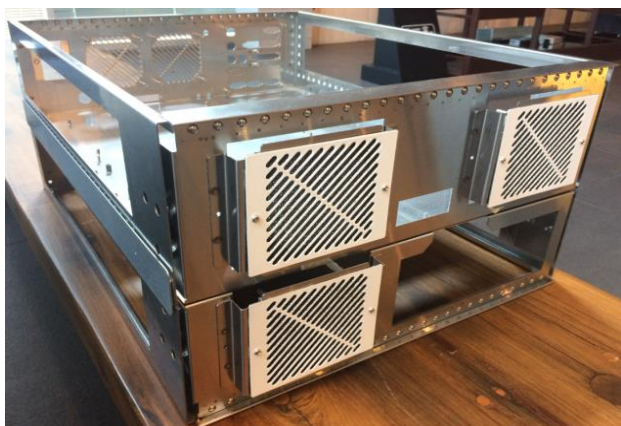
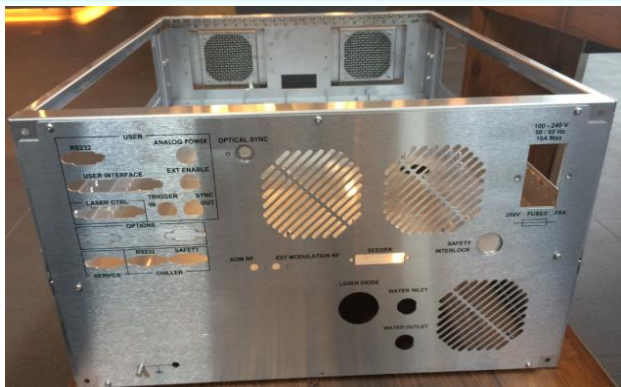

# 遠端控制設備

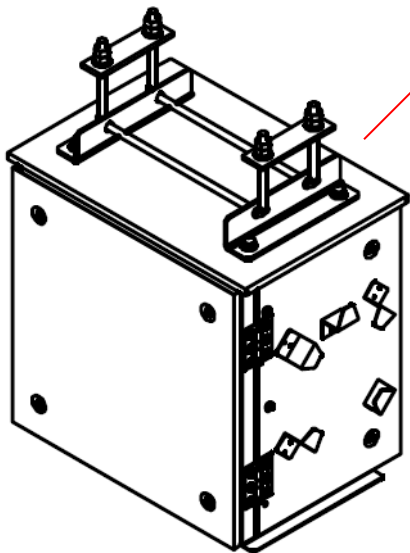

柱上開閉器子装置



# 遊戲機





# 航太類產品

# OUR AEROSPACE PROGRAM



A320



EC225



A340



G650



A350



C919



787



A400M

# 駕駛艙航電機構件

## Aerospace Products





## Aerospace Products

# Electrical Flight Control System Computers Enclosures

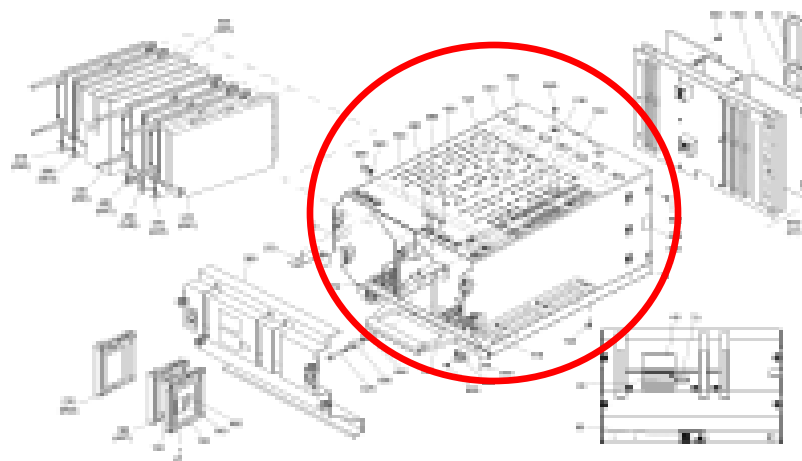
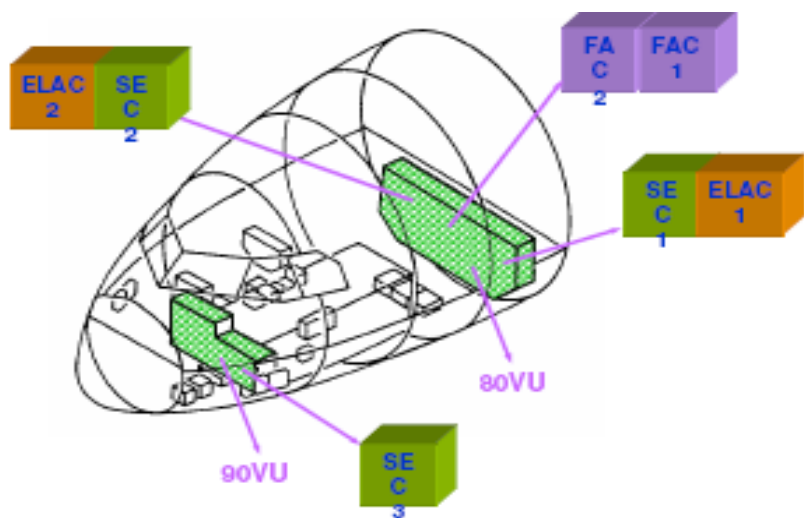

# 駕駛艙航電機構件



Totally JINPAO  
produce 56 different  
part numbers for  
A350



Transformer  
Rectifier Unit

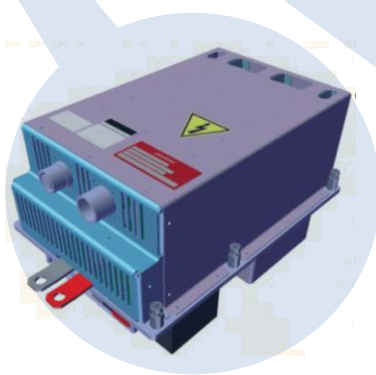

Regulated  
Transformer  
Rectifier Unit



Auto  
Transformer  
Unit



Electrical Flight Control  
System Computers  
Enclosure

# 引擎零組件

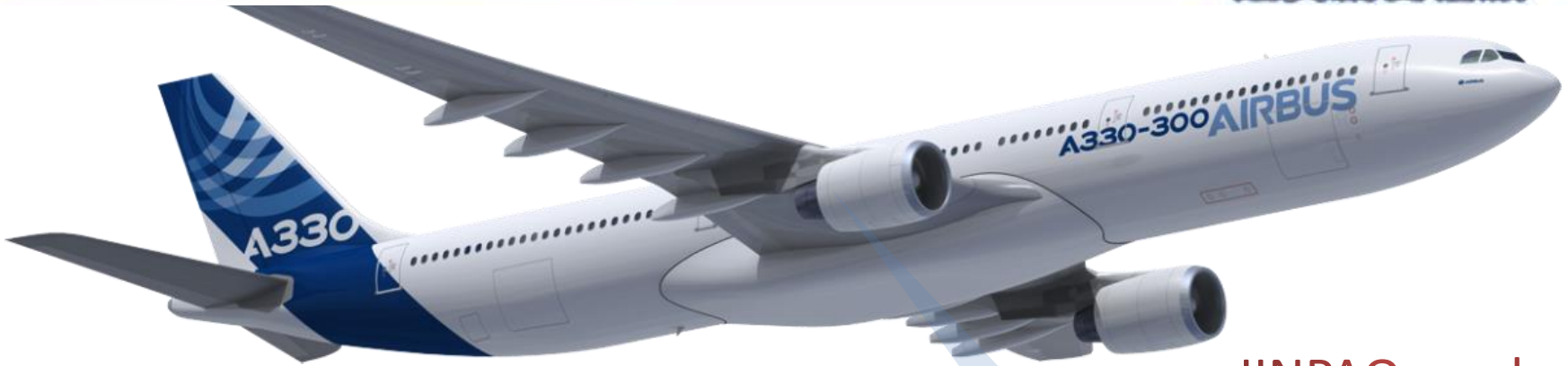

JINPAO produce  
sheet metal parts  
for airplane engine

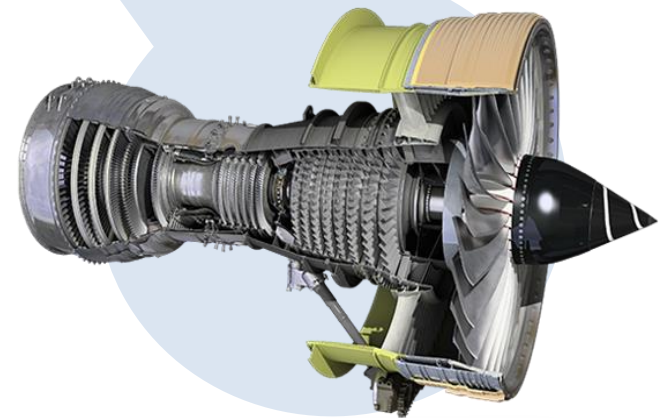

Trent-700 (Rolls-Royce)

# Airbus 衛星零組件



THEOS-2

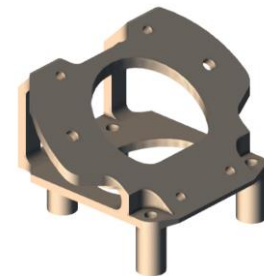
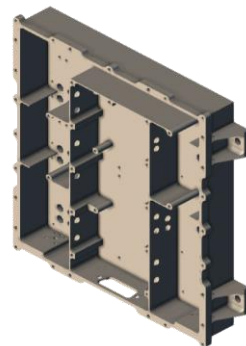
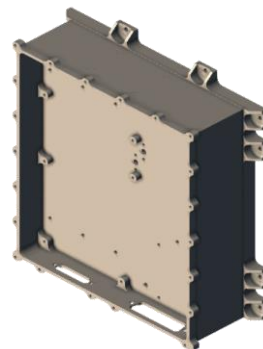
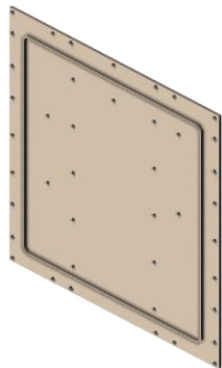
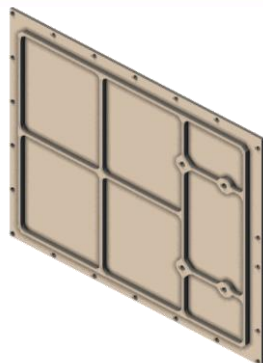

Star Tracker  
Interface Bracket  
(Titanium)

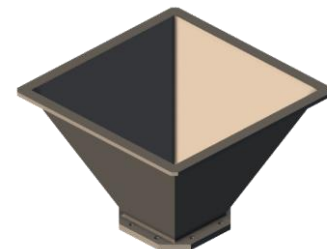

X-Band Horn  
Antenna (Aluminum)

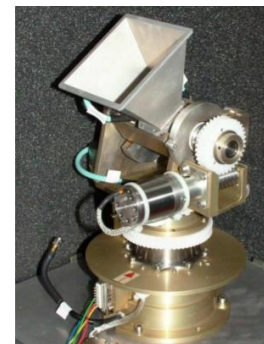





其它類產品

# 車用零組件

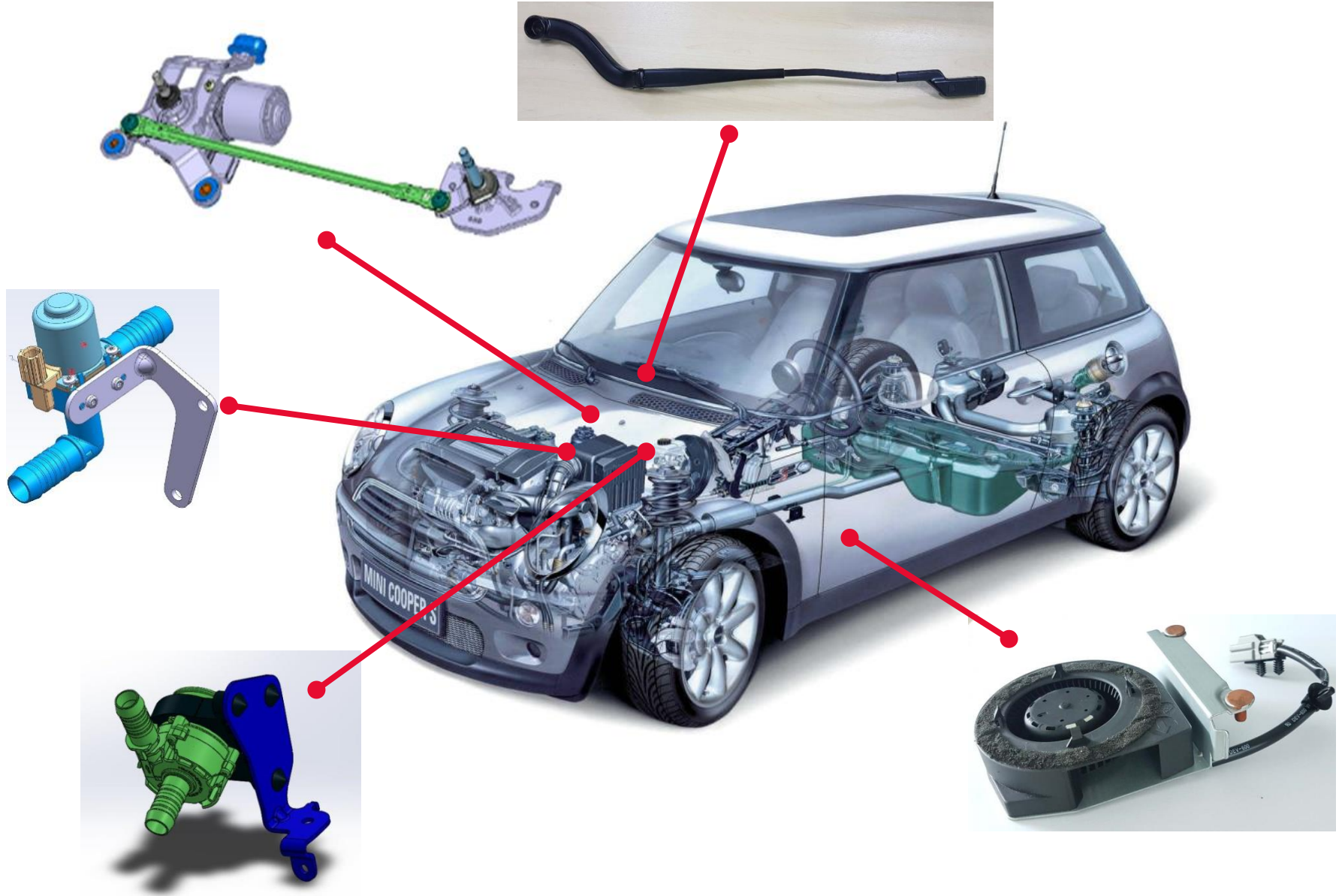

# 壁掛式電動車充電站



## Mini Changer

- Wall Type 15A.
- Wall Type 32A.

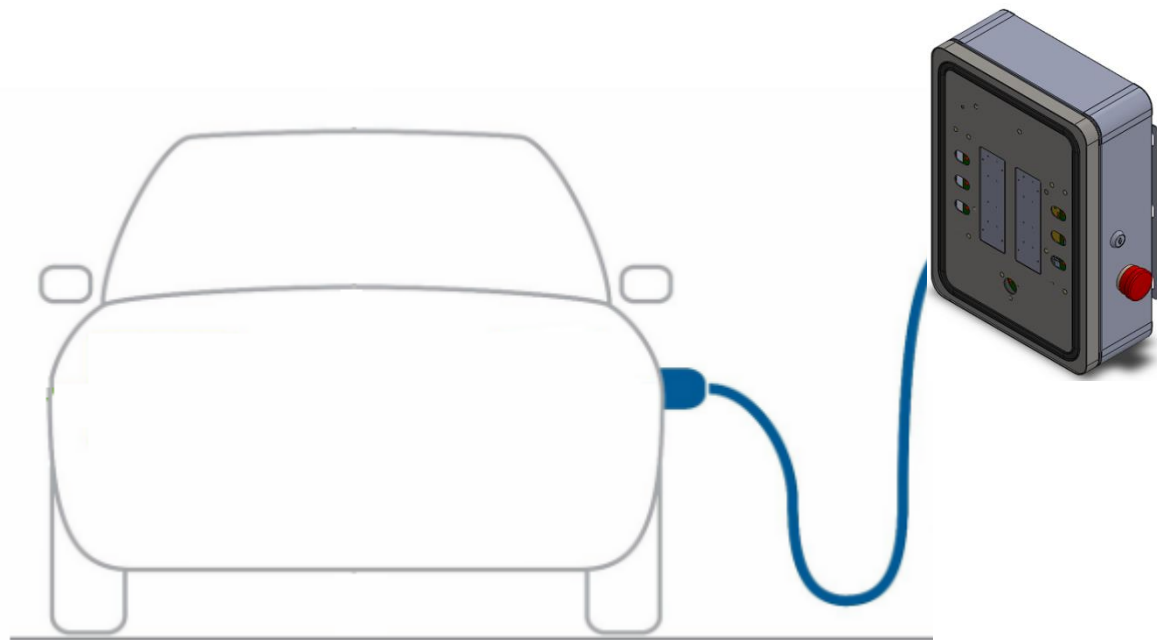
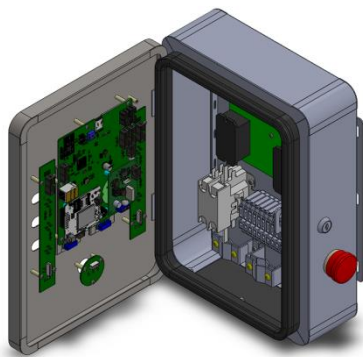

# 電動車充電樁



# 智能儲物櫃



暗証番号及びICカードで  
開閉が可能な電池式宅配ボックス



暗証番号とICカードが使える。  
スマートフォンと同じ様にタッチパネルを採用、  
簡易なタッチ操作。  
起動ボタンを押して、ICカードを近づけるだけで  
施錠解除ができます。  
ダイヤル式認証に比べセキュリティに優れています。



# 捷運售票機

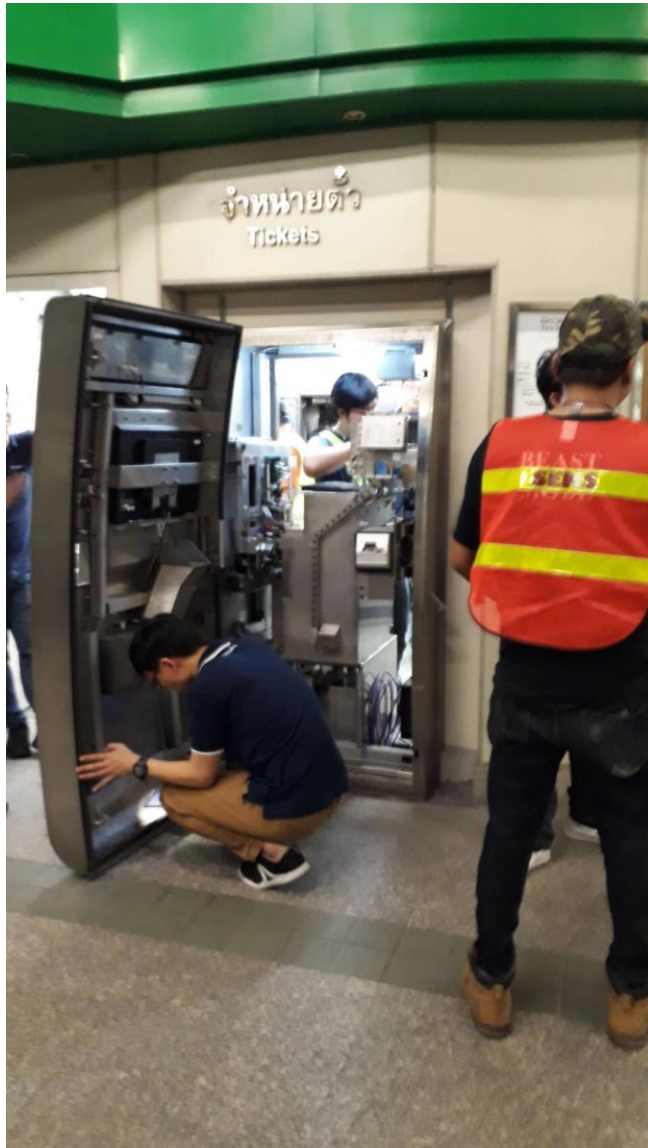

# 醫療消毒設備

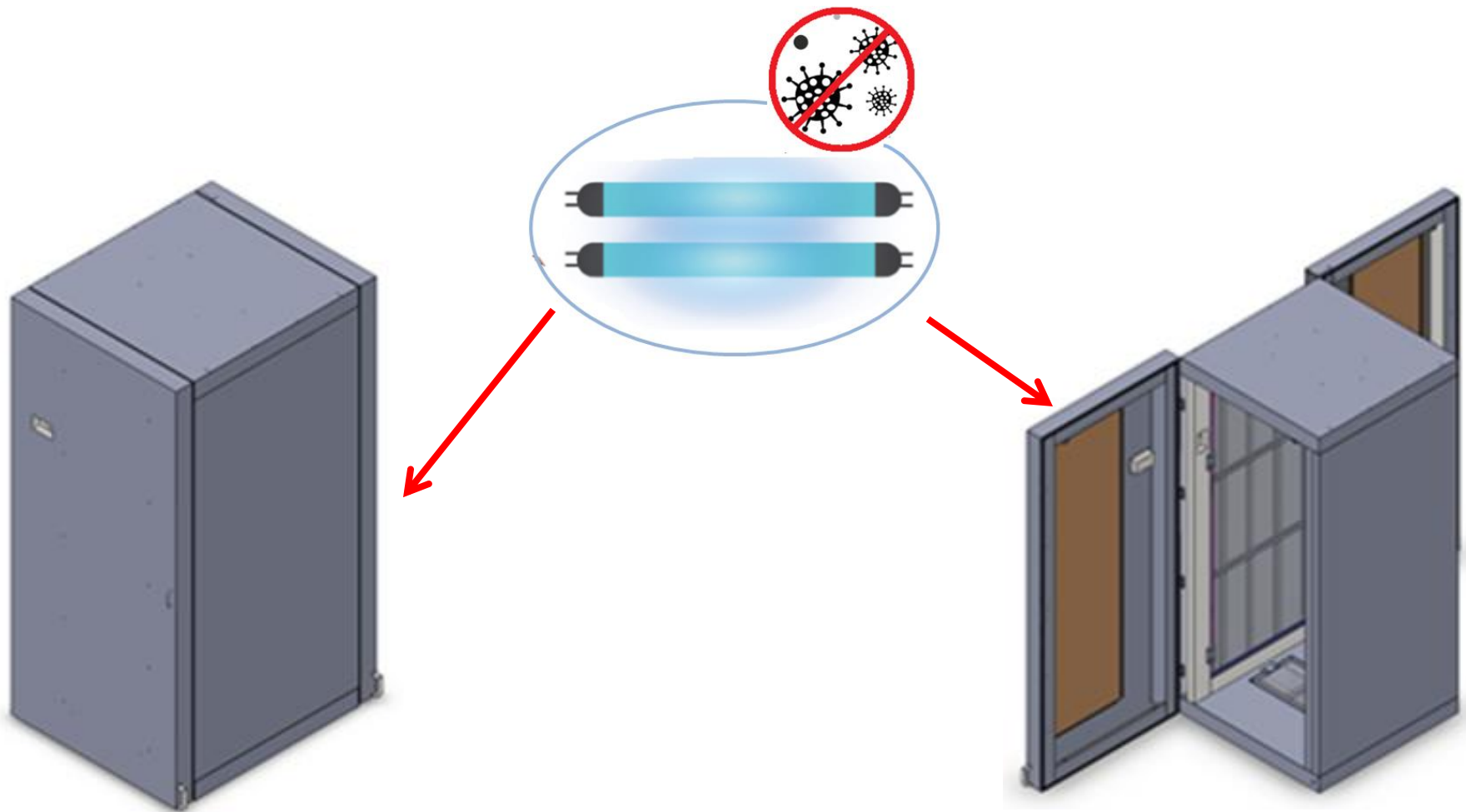

**Ultraviolet disinfection equipment**

# 內視鏡影像處理器

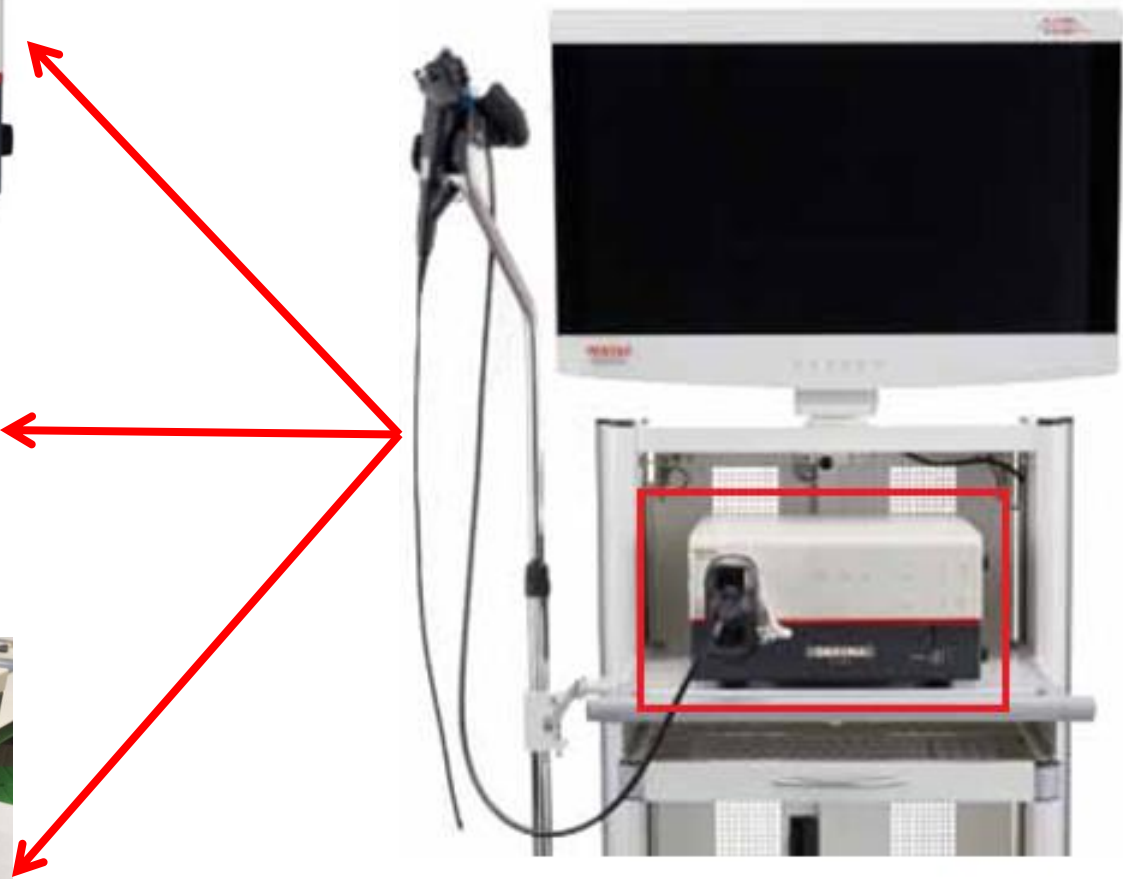



## Food Industry Products



X-ray Metal Checker



Automatic Combination Weighers

# 加油站付費系統

**JINPAO**  
JPP Holding Co., Ltd.  
經實精密控股



# 加油站付費系統



# 加油站付費系統



# 經營績效



# 財務報表

(經實開曼/單位新台幣：仟元)

	2019	2020	2021	2022	2022Q1	2023Q1
<b>損益表</b>						
營業收入	1,437,581	1,259,442	1,350,982	1,789,193	391,375	559,071
營業成本	991,453	861,414	903,370	1,141,191	251,474	325,488
營業、管銷及研發費用	310,478	284,188	282,525	325,578	74,528	87,124
營業利益	135,650	113,840	165,087	322,424	65,373	146,459
稅前利益	105,322	128,452	168,760	304,884	63,744	139,411
本期淨利	90,678	117,284	124,736	243,180	48,830	120,937
<b>EPS (新台幣元/每股) 基本</b>	<b>2.31</b>	<b>2.65</b>	<b>3.00</b>	<b>5.45</b>	<b>1.12</b>	<b>2.52</b>
<b>資產負債表</b>						
流動資產	1,344,157	1,103,539	1,072,381	1,615,504	1,180,181	1,537,162
非流動資產	1,975,519	2,141,340	1,856,006	2,108,185	1,921,142	2,140,110
資產總計	3,319,676	3,244,879	2,928,387	3,723,689	3,101,323	3,677,272
流動負債	927,150	769,089	1,007,656	1,317,770	1,081,877	1,172,801
非流動負債	494,613	628,175	264,009	321,850	263,374	291,108
股東權益合計	1,878,426	1,817,074	1,635,125	2,084,069	1,756,072	2,213,363
負債及股東權益總計	3,319,676	3,244,879	2,928,387	3,723,689	3,101,323	3,677,272
<b>財務比率</b>						
毛利率 (%)	31.03%	31.6%	33.13%	36.22%	35.75%	41.78%
營業利益 (%)	9.44%	9.04%	12.22%	18.02%	16.7%	26.2%
淨利率 (%)	6.36%	9.31%	9.23%	13.59%	12.48%	21.63%
股東權益報酬率 ROE (%)	5.26%	6.35%	7.12%	13%	2.88%	5.62%
負債占資產比率 (%)	42.83%	43.06%	43.43%	44.03%	43.38%	39.81%

資料來源：損益表與資產負債表經會計師查核簽證，財務比率為公司自結。

# 營收分布

2022全年

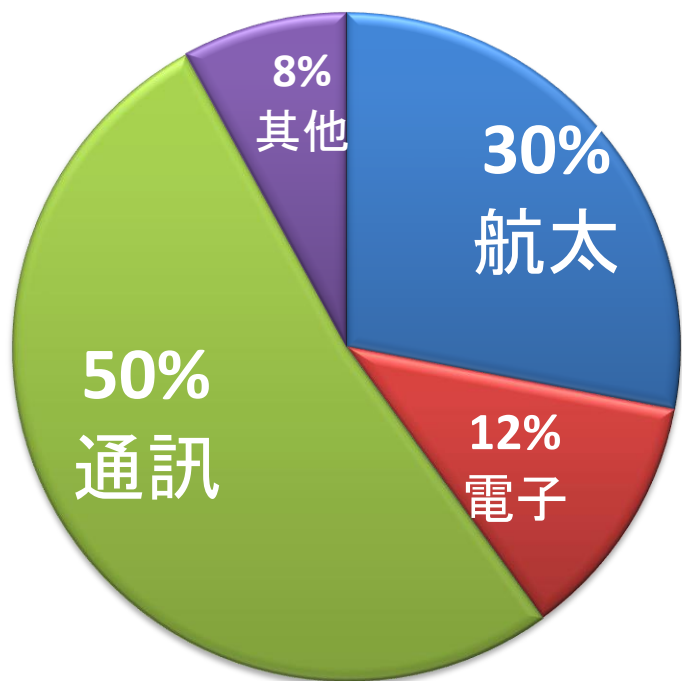

2023Q1

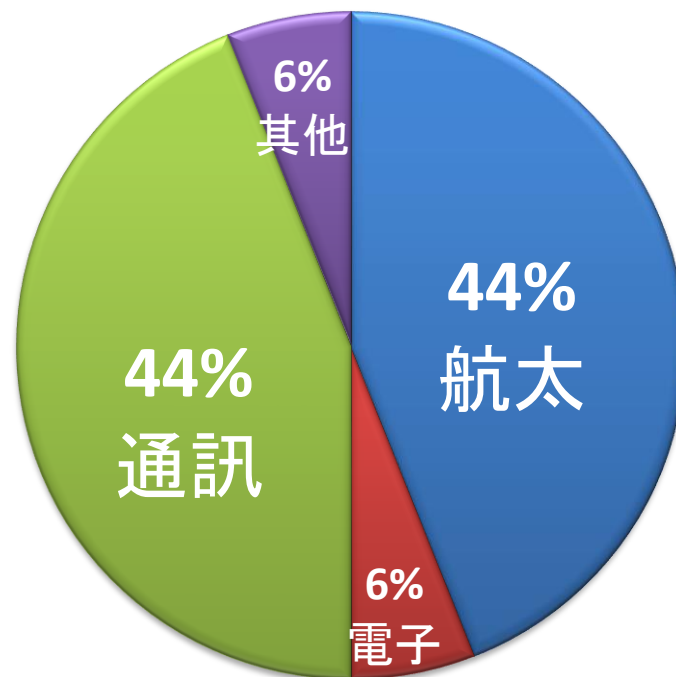

# 客戶分布

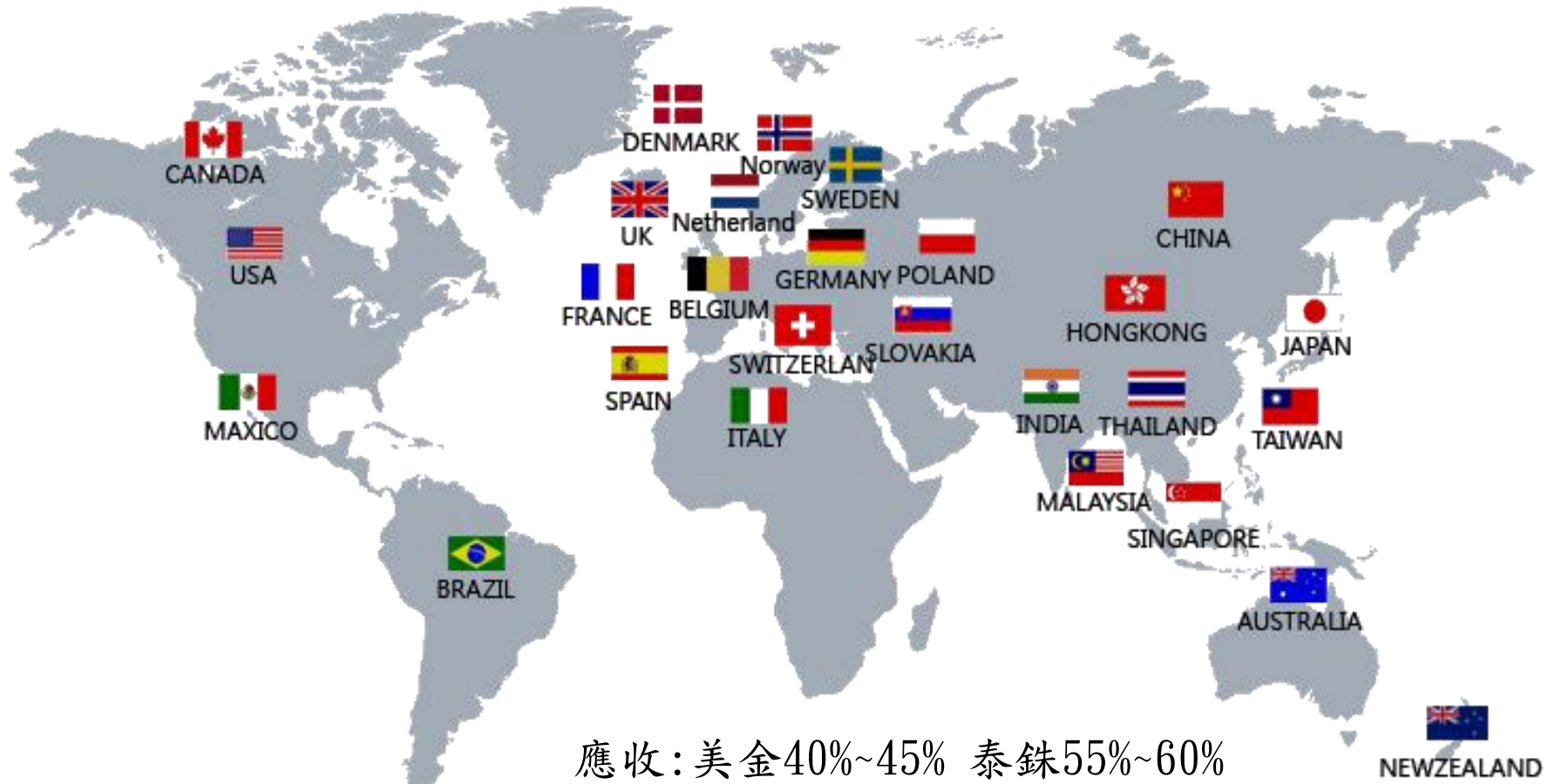

應收：美金40%~45% 泰銖55%~60%

應付：85%~90%內購(泰銖)





未來展望

# 商用伺服器機構件

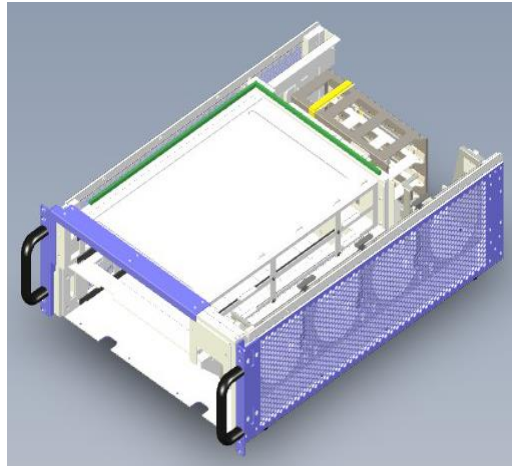
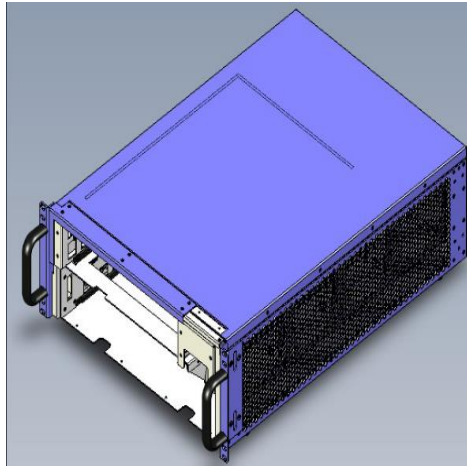
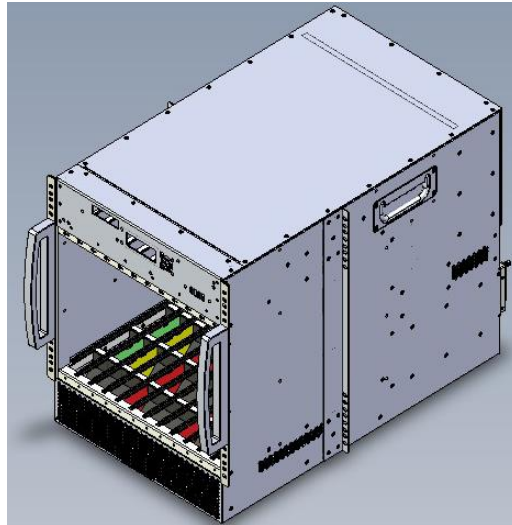
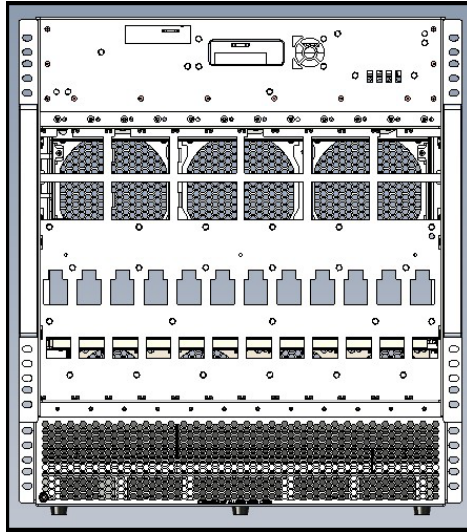

# Data Center

## - Server

New Tooling MP  
2022 Q3  
2022 Q4

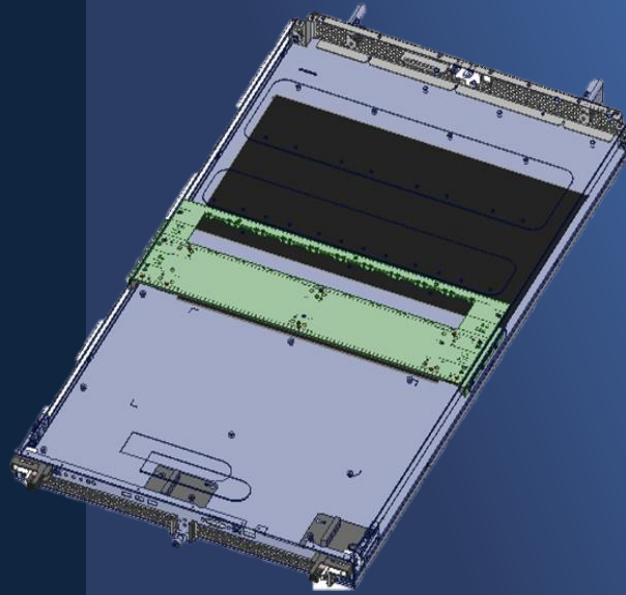

1U 3 Model

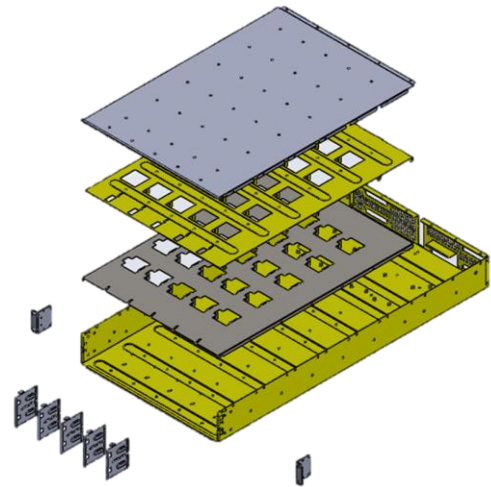
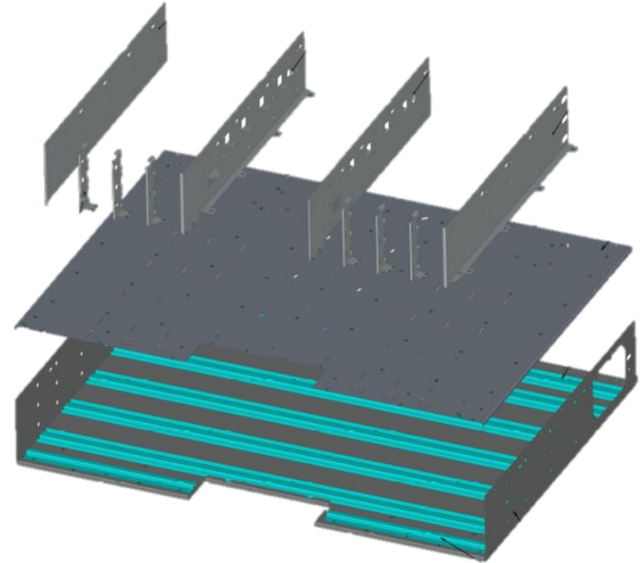

## Data Center

### -Rack

42U

48U

48U Open Rack



# Model PCB Assemble

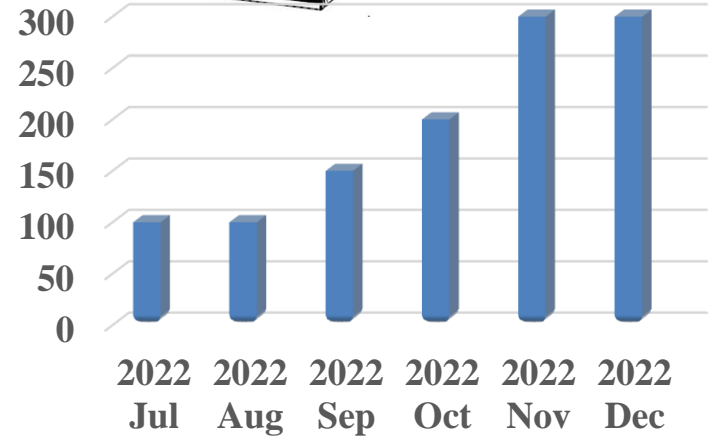
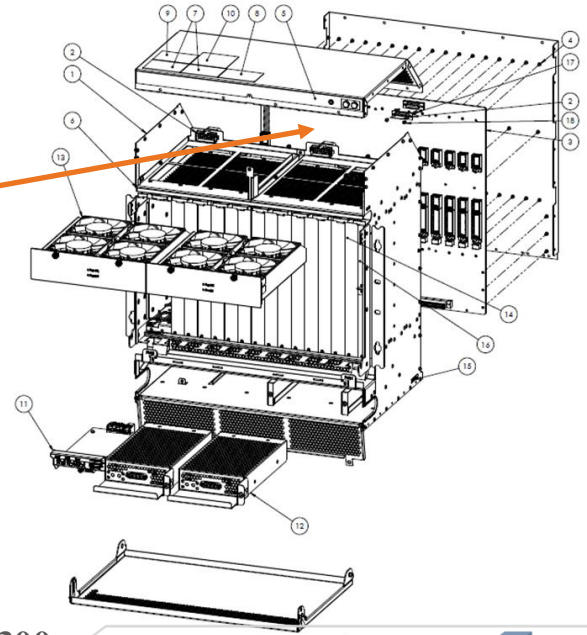
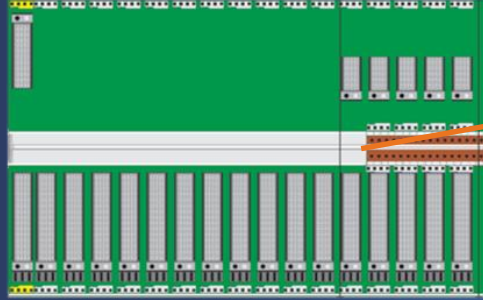

# 數位咖啡機



# Manufacturing Equipment

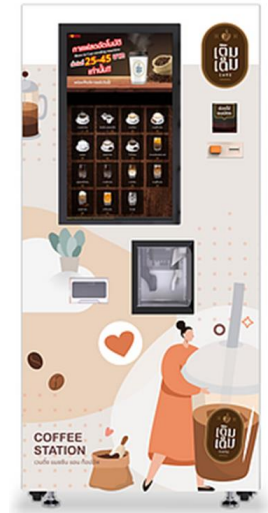

## Delivery per day

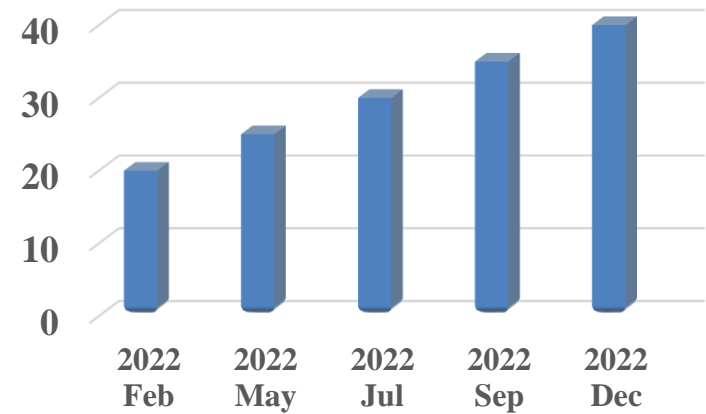

PROPRIETARY INFORMATION

# Medical Equipment

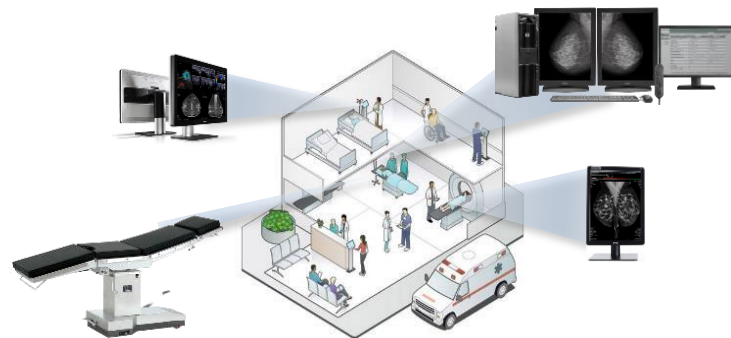
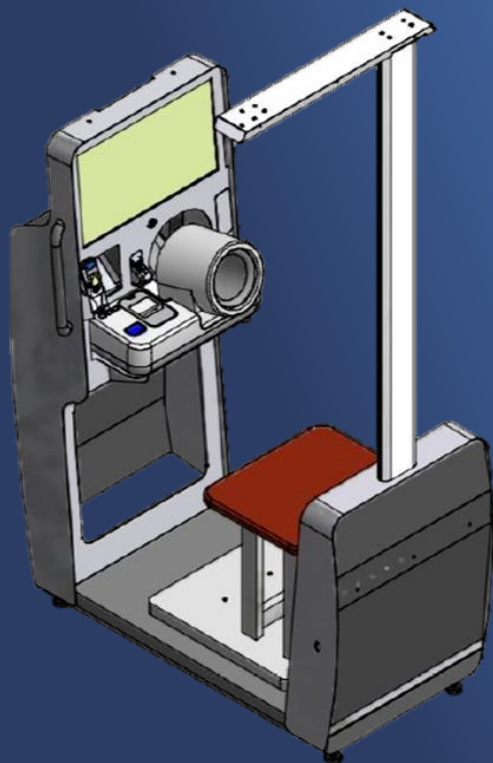

Ultrasound body height detector  
 Seated body weight scale  
 Medical grade tunnel sphygmomanometer  
 Wireless thermometer  
 Optional parts





i motor



# Introducing History & milestones

## JINPAO

- Concept
- Original Design Manufacturer

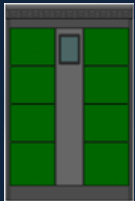

2021  
Feb

## JINPAO & Outsource

- R&D on battery related topics
- Design of electronic part
- Develop Application & Control



2021  
Mar

## JINPAO

- Assembly & Install to Cabinet.
- Cabinet.
- Wiring diagram.
- Built in program.



2021  
Apr

## JINPAO

- Test for the efficiency of charging the battery.
- Temperature.
- Cost of charge.



2021  
May

## JINPAO

- API for creating platform.
- Payment.
- Parameter of Battery.



2021  
Jun

## JINPAO

- Battery charger development
- Low cost.
- Open parameter.
- Communicate in RS232 format.

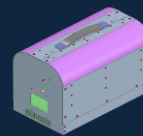

2021  
Dec

## JINPAO & Outsource

- R&D on multi-voltage charge topics
- Design of electronic part
- Optimized by experts
- Design of electronic part
- Develop Application & Control



2022  
Feb Mar

## JINPAO

- API for creating platform.
- Payment.
- Parameter of Battery.
- Update display to show battery charging parameters
- Trial Run.



2022  
Jun

## JINPAO for NSTDA

- Concept
- Original Design Manufacturer
- Developed a multi-voltage battery charging system.

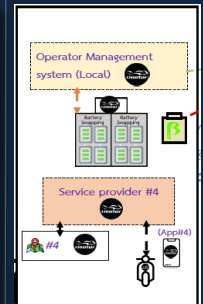

2022  
Jul Aug

2023

# Battery swapping Application

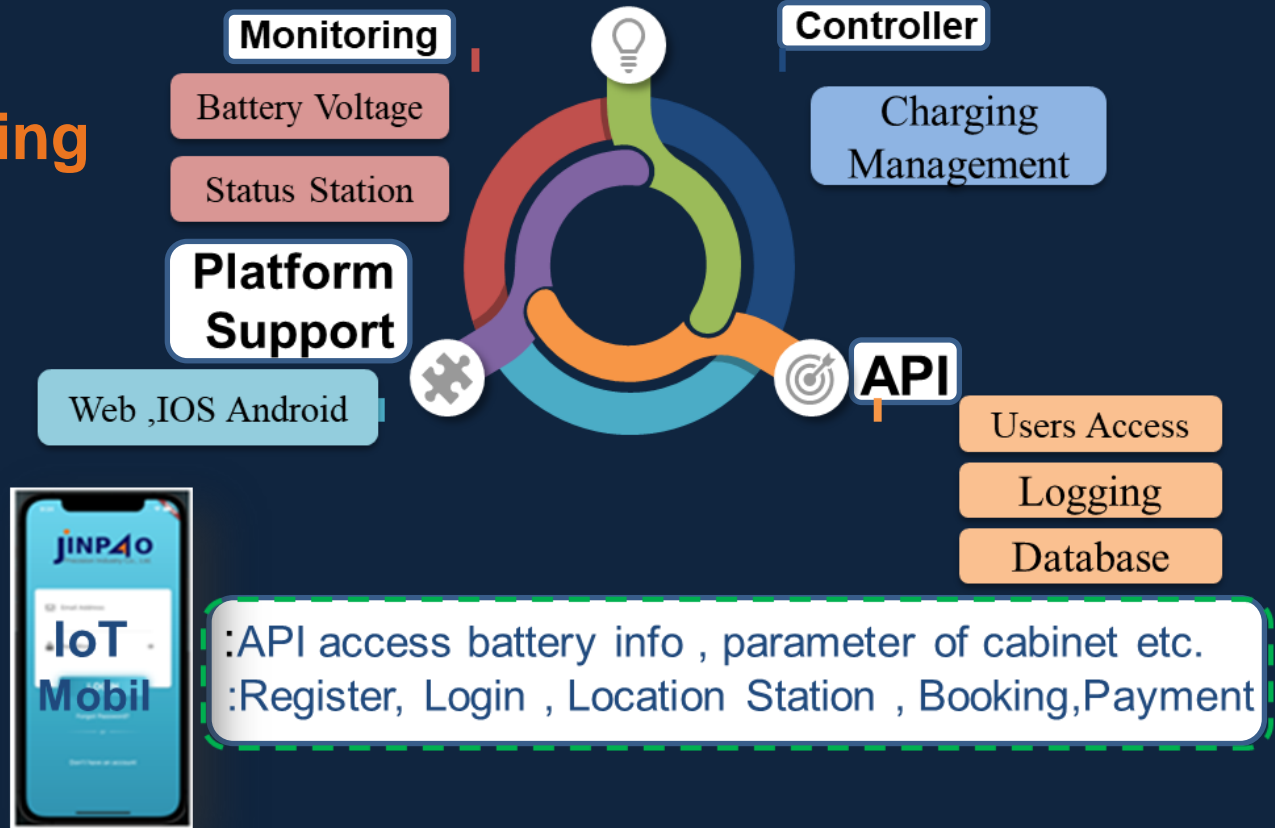

# JINPAO APP

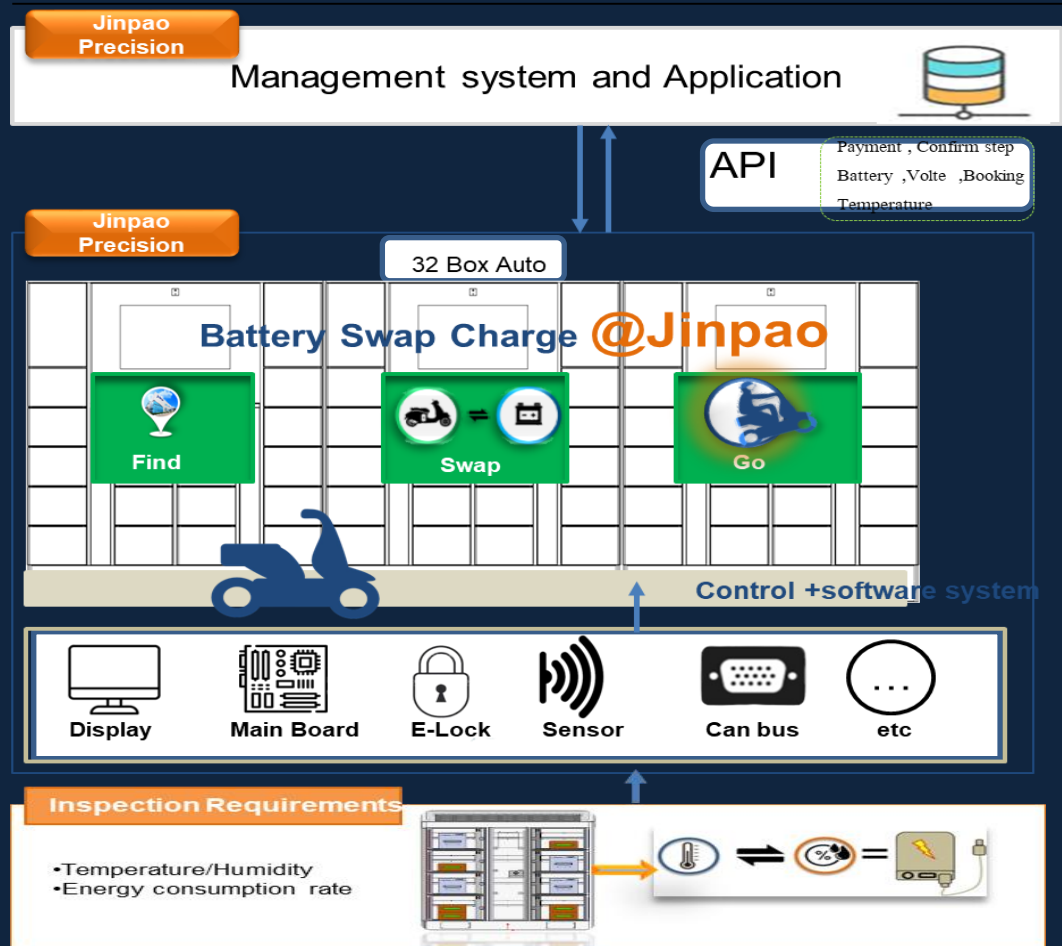

# JINPAO APP

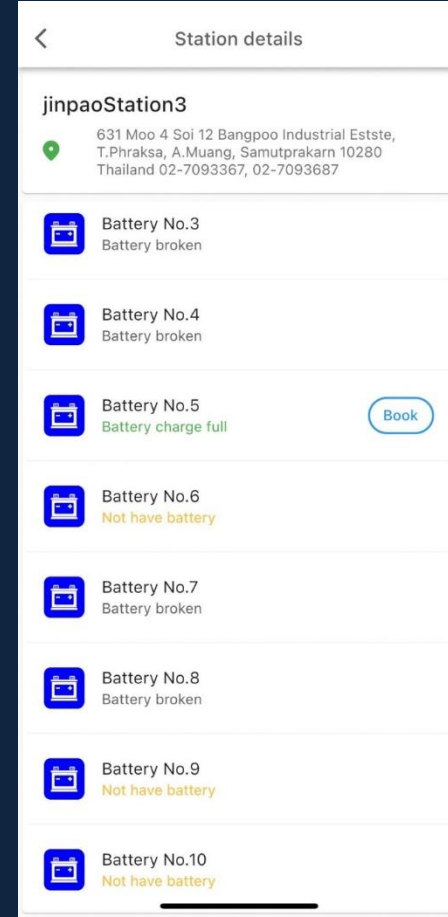
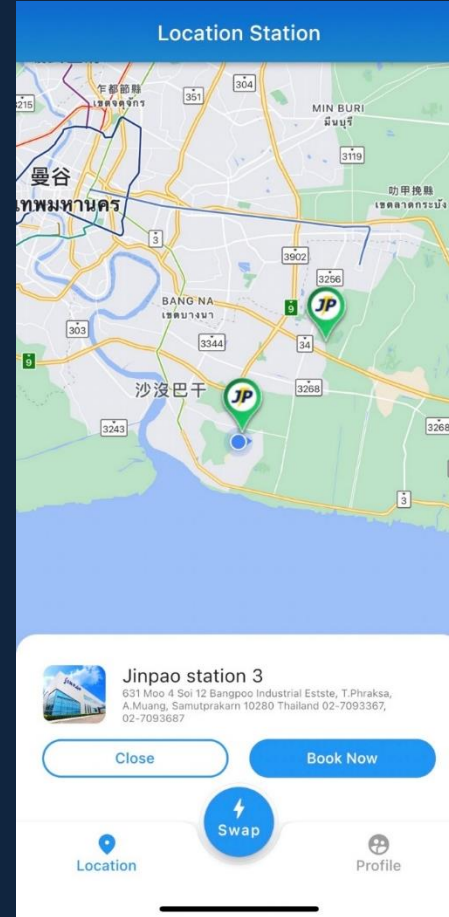
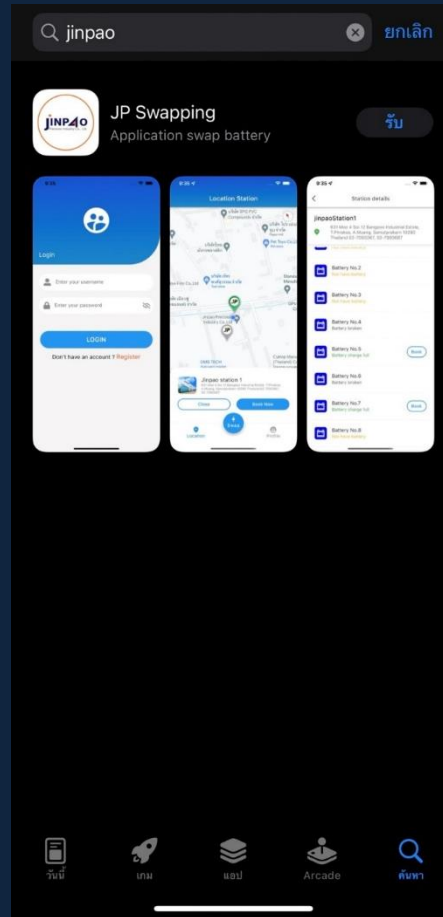

# Charger and Swapping stations

## Energy



### FEATURE AND SPECIFICATION

RFID / Scan payment  
Full charging time : 1~5 hours  
(depend on type of battery)  
Charging power :  
72V 40A max 2880W  
Charge 2 battery / station  
Charge status indicator and alert  
sound.

### PROPRIETARY INFORMATION

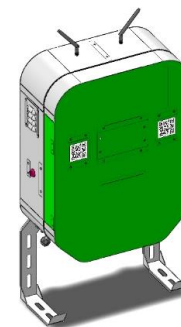

# Electric scooter



## Vapor

- Design in Thailand
- Made in Thailand



# Electric scooter



## - TRAGETED GROWTH -



Winnonie



Grab



Big C

[www.imotorthailand.com](http://www.imotorthailand.com)



# Electric scooter



2022 Jun

Delivery 260,000

Motor Taxi 155,000

Bangkok 80,000



# 7-11 Delivery

2022 Jun  
13,534 Stores



# 7-11 Charger



## PPT Gas Delivery



**PTT Gas Station**

**2022 Jun 2,100 stations**

# Swapping stations ( HONDA )

Global SPEC

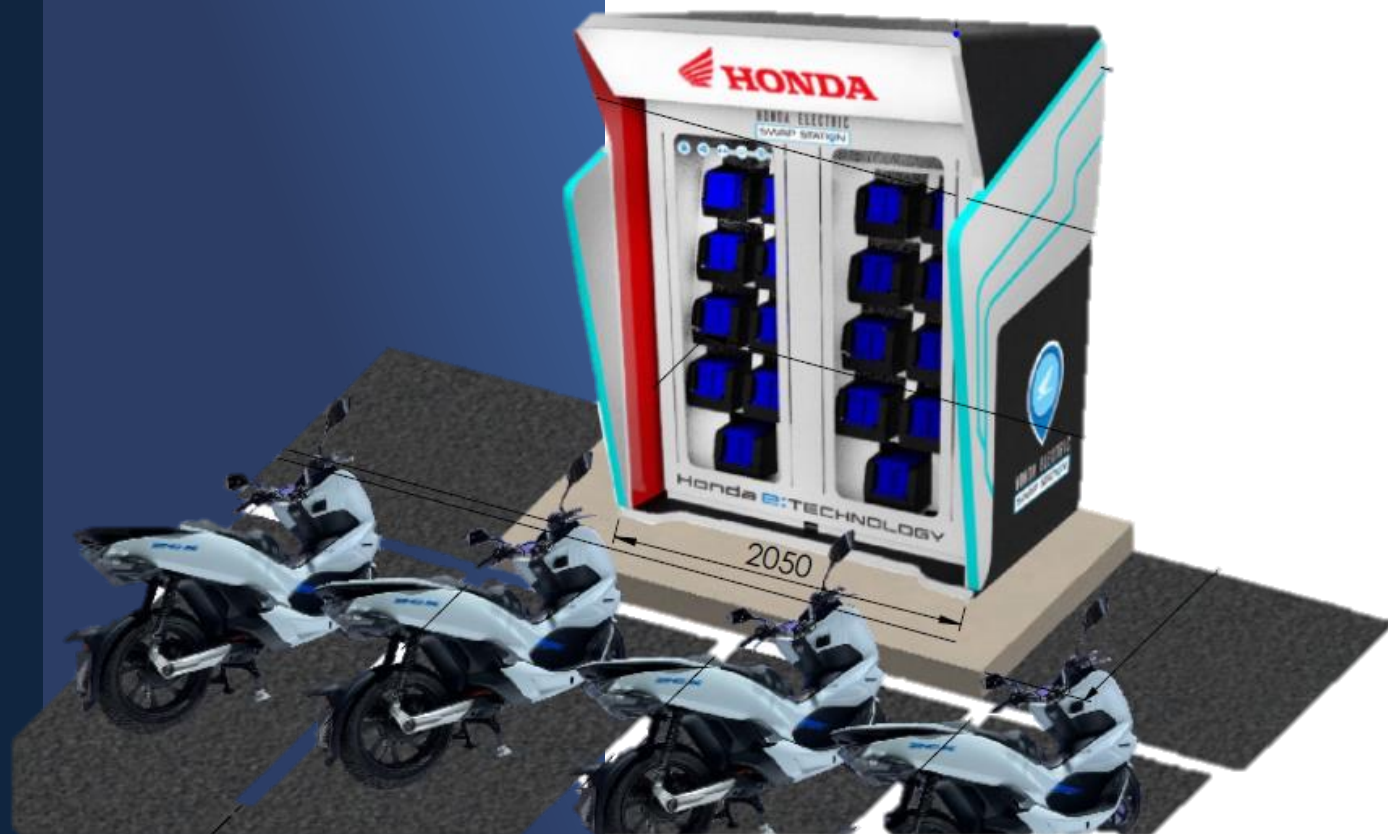

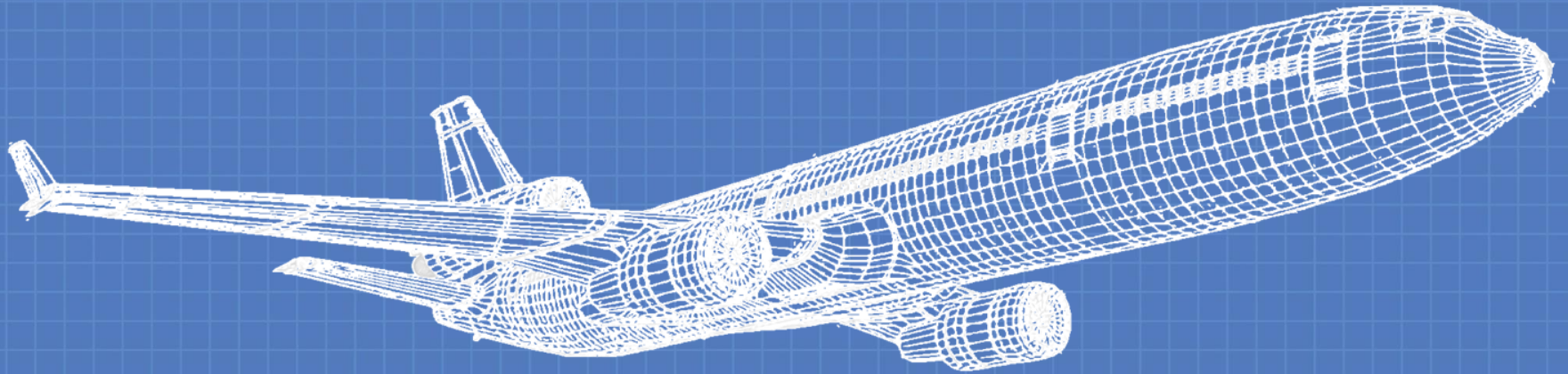

2022-2023 • JINPAO © • Thailand

# JINPAO Precision Industry

## Aerospace and Defense projects

## Diversified Aerospace Programs (Portfolio)



# 客戶生產計畫

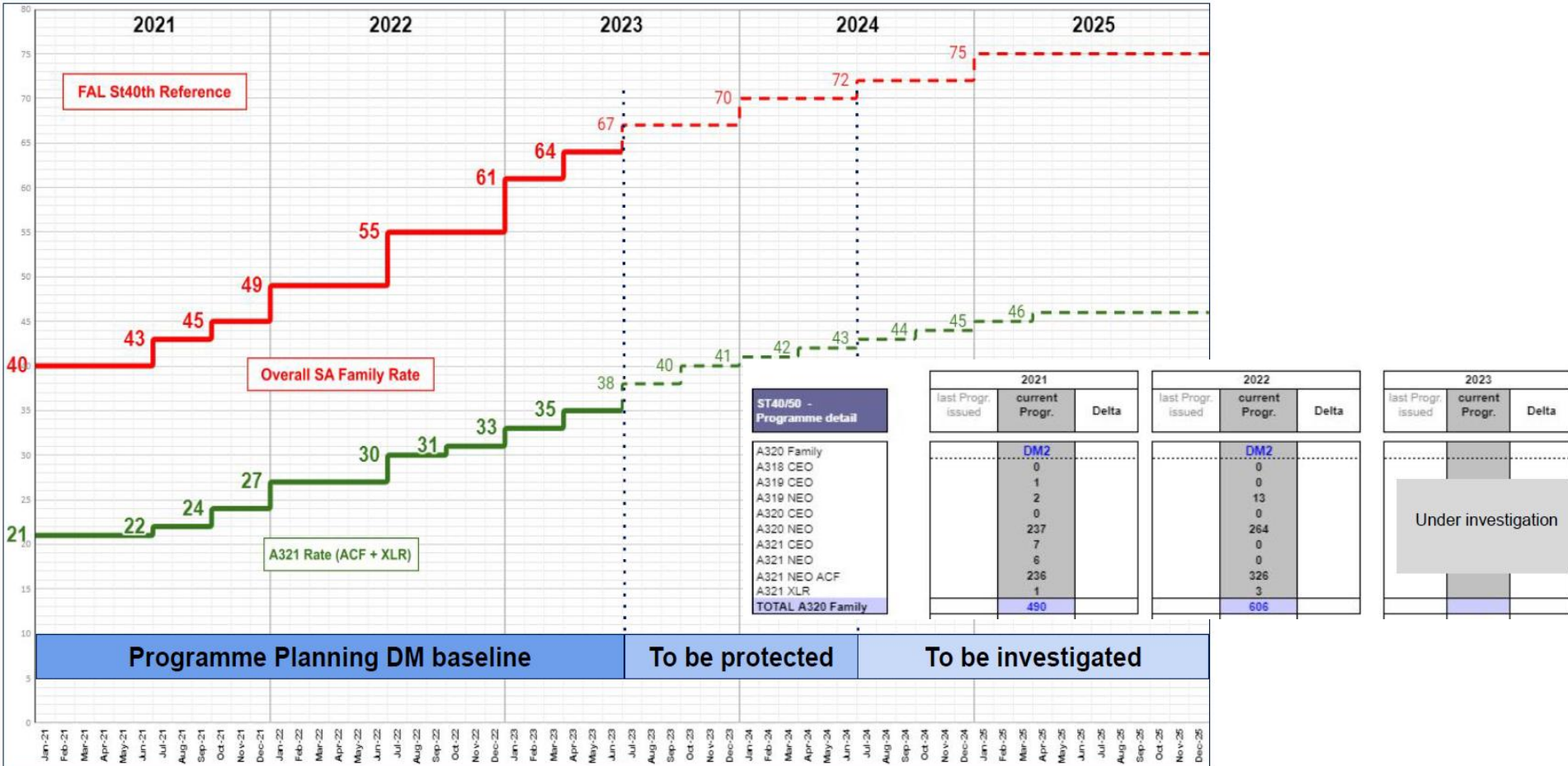



# 陽極處理廠



# 航太目標產品



Structural Sheet metal Parts



Winglets



Flaps, Spoilers, Ailerons



Fuselage elements

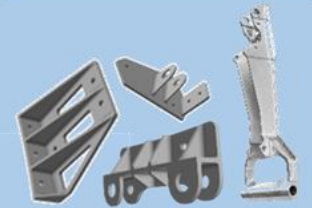

Brackets, Structural Parts and Assemblies



Sheet metal Parts for consoles



Main Landing Gear Kits and Assemblies

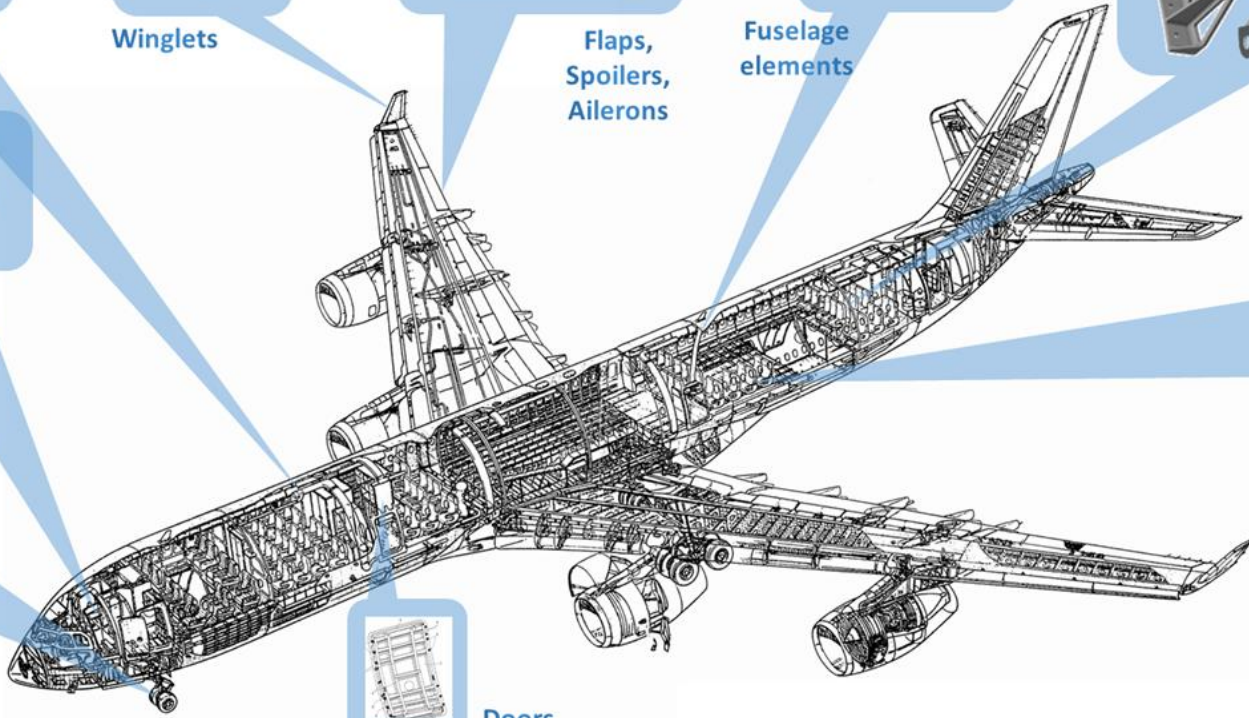

Doors

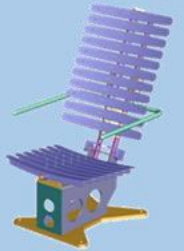

Seats

# ADB PRODUCTION



- Aluminum
- Stainless steel
- Treated steels
- Inconel's Alloys
- Titanium
- Plastics
- Brasses
- Bronzes
- Cuivreu



# ADB SALES REVENUE

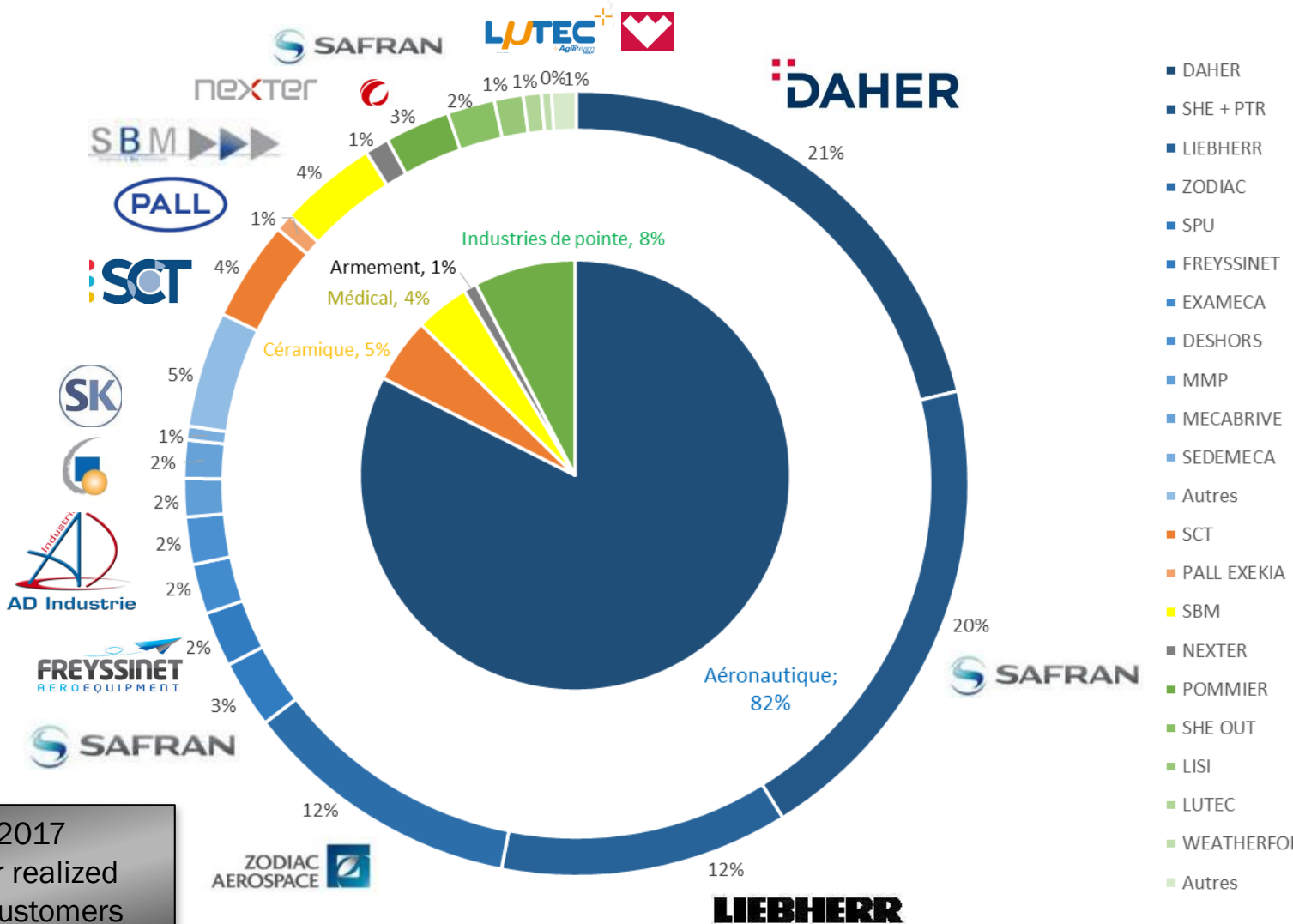

80% of 2017 turnover realized with 8 customers

# ADB SALES REVENUE

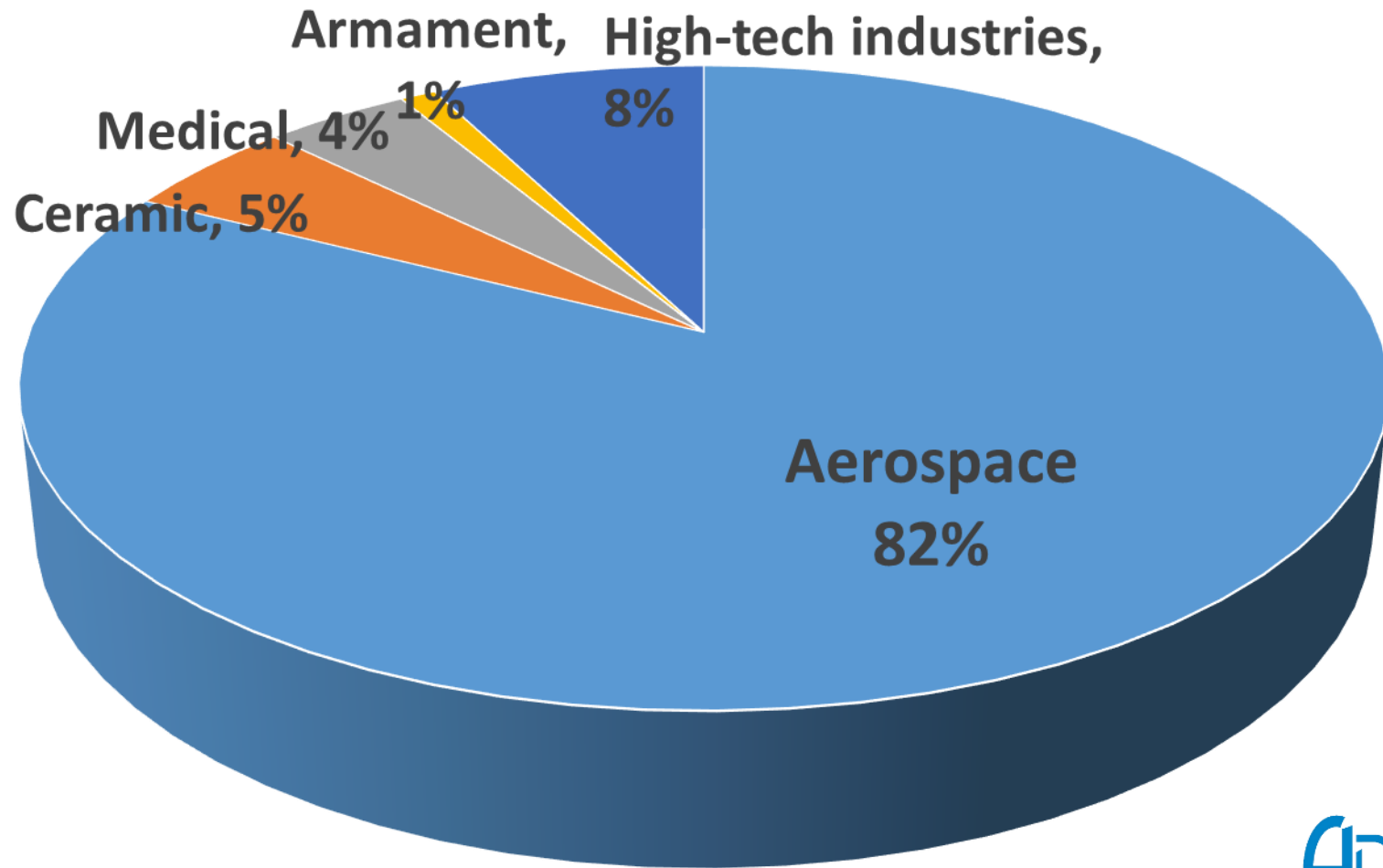

# LUTEC PRODUCTION



- Aluminum
- Stainless steel
- Treated steels
- Titanium
- Plastics
- Inconel's Alloys
- Fonts
- Copper

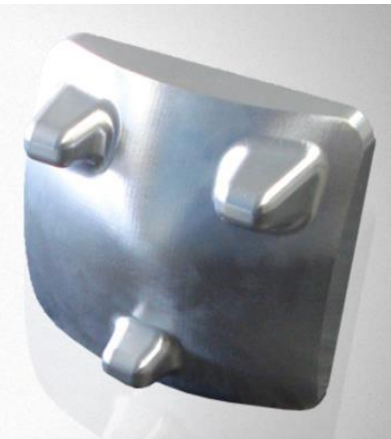
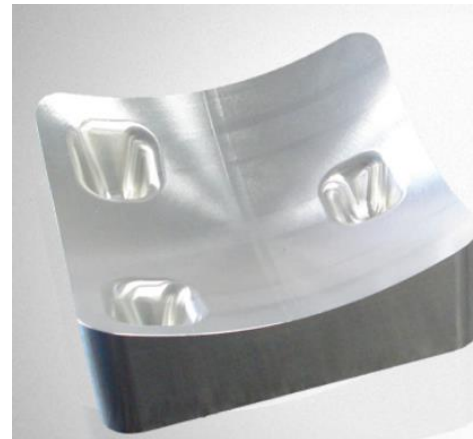

# LUTEC SALES REVENUE

## LUTEC : UN PORTEFEUILLE DE CLIENTS DIVERSIFIÉ

RÉPARTITION DU CA 2017  
PAR CLIENT ET PAR SECTEUR

INDUSTRIES DE  
POINTE (42 %)

MEDICAL (5 %)

AÉRONAUTIQUE, SPATIAL &  
DÉFENSE (53 %)

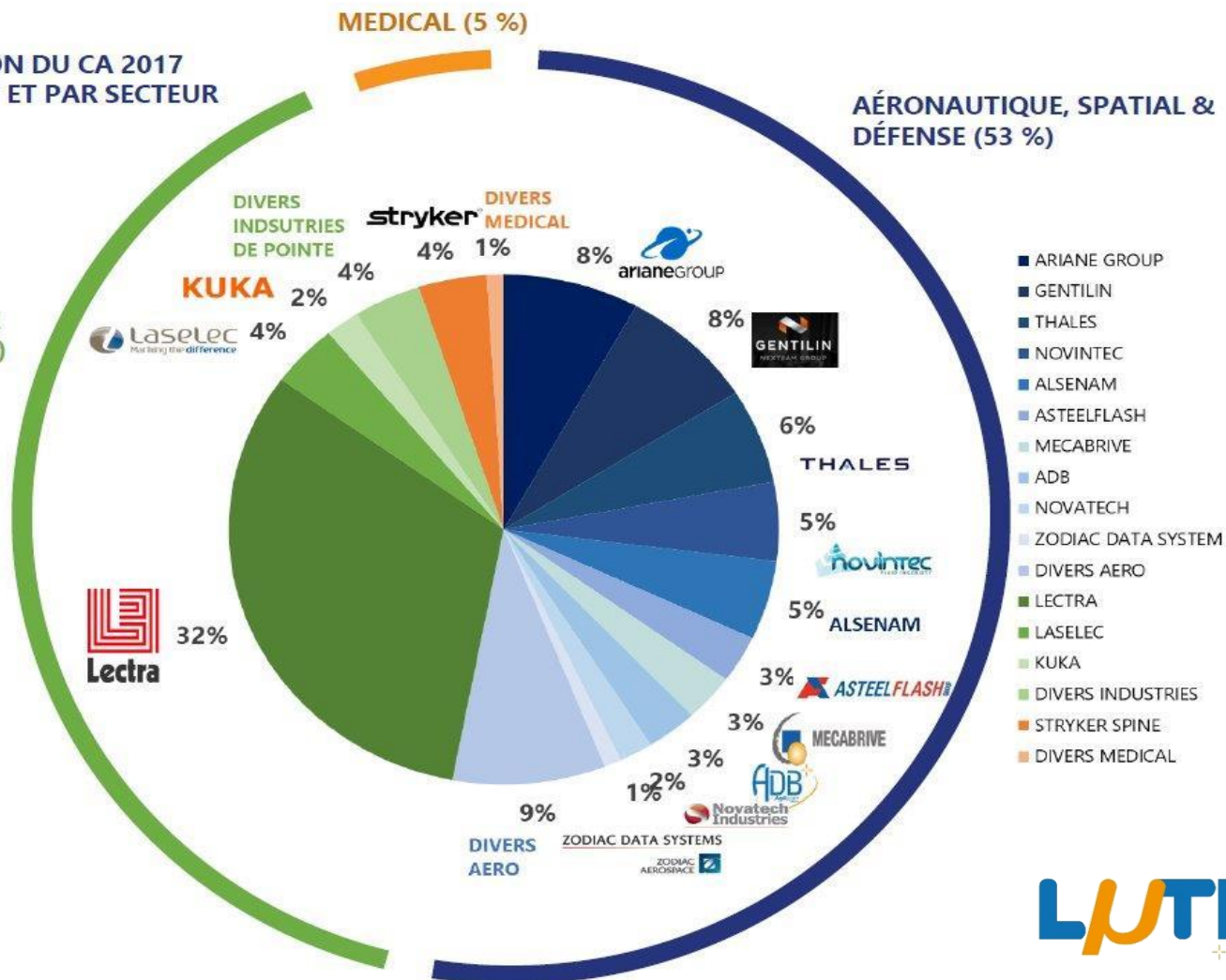

# LUTEC SALES REVENUE

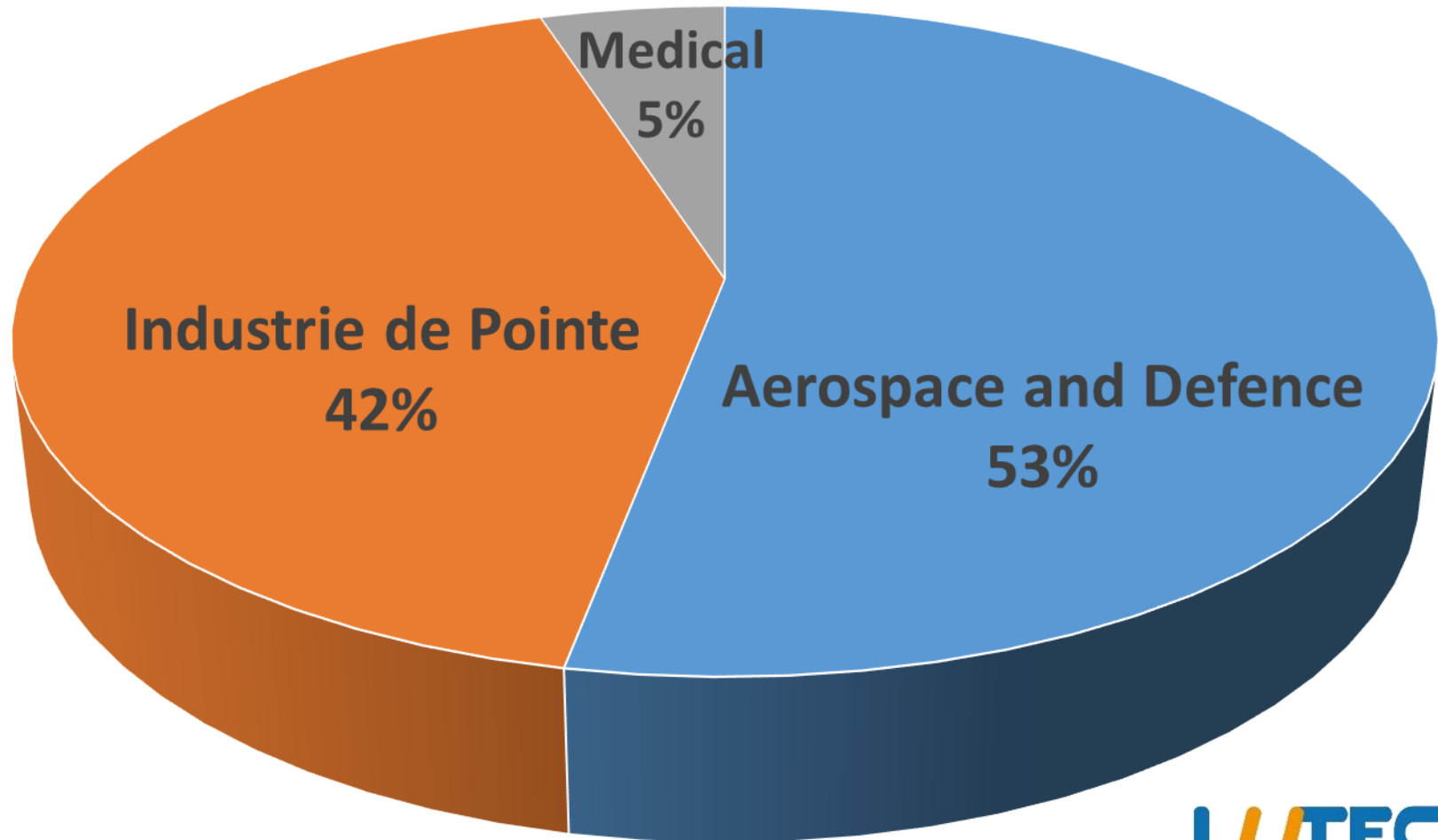



# EASA CERTIFIED DOMAIN



Wefly is an international aviation training academy. A Thai-Italian cooperation program, partnered with EASA Certified Organisations.

- EASA Part-147
- EASA Part-145, CAMO
- EASA DOA, POA
- EASA ATO

- EASA Part-145
  - Part-145 Approval is a company level certification to the European Commission Regulation standards of design, production, Maintenance, Repair and Overhaul of aircraft (MRO).
- EASA Part-147
  - Part-147 is the certified EASA training organization that regulates the approval of maintenance training organisations.
- EASA ATO
  - An ATO is an Approved Training Organisation. They are approved to deliver flight & maintenance training.

- EASA CAMO
  - Continuing airworthiness management organisation (CAMO) is a civil aviation organisation authorized to schedule and control continuing airworthiness activities on aircraft and their parts.
- EASA DOA
  - DOA is a design organisation (approval) responsible for the design of aircraft, related parts and appliances, and for changes or repairs. design approvals.
- EASA POA
  - POA is a production organisation approval.





## TRAINING COURSES

### Aircraft Maintenance Engineer

Basic Training Courses  
 Skilled Engineer Course  
 Module & Examination Packages  
 Type Training  
 Specialised Training Courses

### Pilot

Pilot Licence Conversion  
 Type Rate Training

## WEFLY PARTNERS

Wefly has a wide range of partners operating in the EASA certified domain and in the worldwide aviation industry.





**Thank you**  
**Q&A**